

Sensing and Control

SC Instrumentation

Signal Conditioning,
Self-Calibrating
Digital Indicators



Model SC500

Honeywell
Sensotec Sensors
2080 Arlingate Lane
Columbus, Ohio 43228, USA
Telephone: (614)850-5000
FAX: (614)850-1111
Toll Free: 1-800-848-6564
E-mail: service@sensotec.com
<http://www.honeywell.com/sensing>
<http://www.sensotec.com>

SC Series Instruction Manual - Model SC500
Model SC500

Document Number: 008-0671-00
Rev. -: March, 2004

 WARNING

The operator of this instrument is advised that if the equipment is used in a manner not specified in this manual, the protection provided by the equipment may be impaired.

CAUTION

Only qualified, service-trained personnel who are aware of the hazards involved should remove the cover from the instrument or connect external wiring to the instrument.

 WARNING
PERSONAL INJURY

DO NOT USE these products as safety or emergency stop devices, or in any other application where failure of the product could result in personal injury.

Failure to comply with these instructions could result in death or serious injury.

Contents	3
Chapter 1	
Introduction	9
1.1 About This Manual	9
1.1.1 Scope	9
1.1.2 Conventions	9
1.1.3 Symbol Definitions	9
1.1.4 Organization	9
1.2 Related Documents	11
1.3 What is the SC Series?	12
1.3.1 Features	12
1.3.2 Chassis Models	12
1.3.3 Channel Types	12
1.4 What is <i>Signature Calibration</i> ?	13
1.4.1 Overview	13
1.4.2 Benefits	13
1.4.3 Information Stored	13
Chapter 2	
Installation	15
2.1 Locate Required Parts and Information	15
2.2 Connect the Transducer to the Input Channel ..	15
2.3 Turn on the Instrument	16
2.4 Use the SETUP Menus to Enter Transducer Information	17
2.5 Calibrate the Transducer to the Input Channel ..	17
2.6 The SC Series Instrument is Ready for Use	17
Chapter 3	
Operating Modes	19
3.1 Operating Modes	19
3.2 INITIALIZE Mode	19
3.3 RUN Mode	20
3.3.1 Display	20
3.3.2 [VALUE] button	20
3.3.3 [CLEAR] Button	20
3.3.4 [CHANNEL] button	20
3.3.5 [TARE] button	21
3.3.6 Indicator Lights	21
3.4 ERROR mode	22
3.5 SETUP Menu mode	23
3.5.1 Available Menus	23
3.5.2 Entering and Exiting the SETUP Menu mode	23
3.5.3 Moving Through SETUP Menus and Menu Items	23
3.5.4 Exiting the SETUP Menu mode	23
Chapter 4	
Chassis Models	25
4.1 Single-Input Chassis	25

4.1.1 Input Channel	25
4.1.2 Options Board	25
4.1.3 Virtual Channels	25
4.2 Specifications	26
4.3 Models SC500 Enclosure	27
4.3.1 External Arrangement	27
4.3.2 Rear Panel	27
4.3.3 Panel Mounting	27
4.3.4 Rack Mounting	28
4.3.5 Bench Mounting	28
4.3.6 Case Removal	29
4.3.7 Internal Arrangement	29
4.3.8 Cleaning	30
4.3.9 Power Connector	30
4.3.10 Wall-Mount AC Power Adapter	30

Chapter 5

Options Connector	31
5.1 Introduction	31
5.2 Accessories	31
5.3 Wiring	32
5.3.1 2 Form C Relays Option	32
5.3.2 3 Form A Relays Option	33
5.4 Relay Output Pins	34
5.4.1 Operation	34
5.4.2 Specifications	34
5.4.3 Diagnostics	34

Chapter 6

System Menu	35
6.1 Overview	35
6.2 Menu Items	35
6.2.1 SOFTWARE REVISION Menu Item	35
6.2.2 CONFIGURATION Sub-Menu	35
6.2.3 DIAGNOSTICS Sub-Menu	35
6.2.4 INSTALL CHANNEL Menu Item	36
6.2.5 DELETE CHANNEL Menu Item	37
6.2.6 DEFAULT CHANNEL Menu Item	37

Chapter 7

Serial Communications	39
7.1 Overview	39
7.2 Wiring	39
7.3 Communications Protocol	40
7.3.1 RS-232 vs. RS-485	40
7.3.2 Parameters	40
7.4 Serial Com Menu	41
7.4.1 Overview	41
7.4.2 INTERFACE Menu Item	41
7.4.3 ADDRESS Menu Item	41
7.4.4 BAUD RATE Menu Item	41
7.4.5 AUTO LINE-FEED Menu Item	41
7.4.6 TRANSMIT TEST Menu Item	41

7.4.7 LEAVE MENU Menu Item	41
Chapter 8	
Display Menu	43
8.1 Overview	43
8.2 Menu Items for Model SC500	43
8.2.1 UPPER CHANNEL Menu Item	43
8.2.2 LOWER CHANNEL Menu Item	43
8.2.3 DISPLAY MODE Menu Item	43
8.2.4 LEAVE MENU Menu Item	44
Chapter 9	
Limits	45
9.1 Understanding Limits, Set Points and Return Points	45
9.2 Wiring	45
9.3 Limit Operation	46
9.3.1 Actions When Activated	46
9.3.2 Scan Time	46
9.4 Limit Menus	47
9.4.1 Overview	47
9.4.2 LIMIT. ENABLE Menu Item	47
9.4.3 LIMIT. SETPOINT Menu Item	47
9.4.4 LIMIT. RETURN PNT Menu Item	47
9.4.5 LIMIT. ENERGIZE Menu Item	47
9.4.6 LIMIT. LATCHING Menu Item	49
9.4.7 LIMIT. CHANNEL Menu Item	49
9.4.8 LIMIT. SOURCE Menu Item	49
9.4.9 LEAVE MENU Menu Item	49
Chapter 10	
Strain-Gage Input Channel	51
10.1 Features	51
10.2 Wiring	52
10.2.1 Strain-Gage Transducers	53
10.2.2 Strain-Gage Transducers with Buffered Shunt Cal ..	54
10.3 Calibration Procedure	55
10.4 Specifications	56
10.5 Channel Menu	57
10.5.1 OPERATION Sub-Menu	57
10.5.2 DISPLAY SETUP Sub-Menu	58
10.5.3 AUX _n FUNCTION Menu Items	58
10.5.4 CALIBRATION TYPE Menu Item	60
10.5.5 CALIBRATION DATA Sub-Menu	62
10.5.6 CALIBRATE Menu Item	64
10.5.7 DAC SETUP Sub-Menu	66
10.5.8 SIGNATURE MODULE Sub-Menu	67
10.5.9 DIAGNOSTICS Sub-Menu	68
10.6 Digital-to-Analog Converter (DAC) Output Configuration	69
10.6.1 Channel Menu Items	69
10.6.2 Output Selection	69
10.7 Troubleshooting	70
10.7.1 Error Messages	70
10.7.2 Common Problems and Solutions	70

Chapter 11	
AC/AC-LVDT Input Channel	73
11.1 Features	73
11.2 Wiring	74
11.3 Calibration Procedure	75
11.4 Specifications	76
11.5 Channel Menu	77
11.5.1 OPERATION Sub-Menu	77
11.5.2 DISPLAY SETUP Sub-Menu	78
11.5.3 AUX _n FUNCTION Menu Items	78
11.5.4 CALIBRATION TYPE Menu Item	80
11.5.5 CALIBRATION DATA Sub-Menu	81
11.5.6 CALIBRATE Menu Item	83
11.5.7 DAC SETUP Sub-Menu	85
11.5.8 DIAGNOSTICS Sub-Menu	86
11.6 Electrical Null and Transducer Mounting	87
11.6.1 Overview	87
11.6.2 Procedure	87
11.7 Digital-to-Analog Converter (DAC) Output Configuration	88
11.7.1 Identifying the Output Type	88
11.7.2 Channel Menu Items	88
11.7.3 Output Selection	88
11.8 Troubleshooting	89
11.8.1 Error Messages	89
11.8.2 Common Problems and Solutions	89
Chapter 12	
High-Level Input Channel	91
12.1 Features	91
12.2 Wiring	92
12.2.1 Channel Connector	92
12.2.2 Bi-polar Voltage Amplifiers	93
12.2.3 "3-wire Voltage" Amplifiers	94
12.2.4 "3-wire Voltage" Amplifiers with Single-wire Shunt Cal	95
12.2.5 "3-wire Current" Amplifiers	96
12.2.6 "2-wire Current" Amplifiers with Buffered Shunt Cal .	97
12.2.7 "2-wire Current" Amplifiers with Single-wire Shunt Cal	98
12.2.8 Low Voltage DC-DC LVDTs	99
12.3 Excitation and Signal Jumpers	100
12.3.1 Overview	100
12.3.2 Setting Jumpers	100
12.4 Calibration Procedure	101
12.5 Specifications	102
12.6 Channel Menu	103
12.6.1 OPERATION Sub-Menu	103
12.6.2 DISPLAY SETUP Sub-Menu	104
12.6.3 AUX _n FUNCTION Menu Items	105
12.6.4 CALIBRATION TYPE Menu Item	106
12.6.5 CALIBRATION DATA Sub-Menu	108
12.6.6 CALIBRATE Menu Item	110
12.6.7 DAC SETUP Sub-Menu	112
12.6.8 DIAGNOSTICS Sub-Menu	113
12.7 Digital-to-Analog (DAC) Output Configuration .	114

12.7.1 Channel Menu Items	114
12.7.2 Output Selection	114
12.8 Troubleshooting	115
12.8.1 Error Messages	115
12.8.2 Common Problems and Solutions	115
Chapter 13	
Split Display Virtual Channel	117
13.1 Features	117
13.2 Wiring	117
13.3 Setup Procedure	117
13.4 Channel Menu	118
13.5 Troubleshooting	118
Chapter 14	
Mathematics Virtual Channel	119
14.1 Features	119
14.2 Wiring	120
14.3 Setup Procedure	121
14.4 Channel Menu	122
14.4.1 SENSOCODE P/N Menu Item	122
14.4.2 USER VALUES Sub-Menu	122
14.4.3 VIEW SENSOCODE Menu Item	122
14.4.4 VIEW COMMANDS Sub-Menu	122
14.4.5 DISPLAY SETUP Sub-Menu	123
14.4.6 POWER-ON SOURCE Menu Item	124
14.5 Troubleshooting	125
Chapter 15	
Error Messages	127
15.1 Overview	127
15.2 Error Message List	128
Chapter 16	
Setup Menu Reference	133
16.1 Navigation instructions	133
Index	145
Warranty	149

1.1 About This Manual

1.1.1 Scope

This manual will explain the setup, features and operation of the Model SC500, a member of the 3rd generation of SC Series instruments.

Further information about customer specific programming and setup will be explained on the Customer Information Sheet that is provided with every instrument.

1.1.2 Conventions





This manual uses the following conventions to present information:

[TEXT IN BRACKETS]	The label of a front panel button.
DISPLAY	Text that appears on the display, such as error messages or menu items.
->	Indicates that what follows is an item from a sub-menu, such as SYSTEM MENU -> DIAGNOSTICS.

1.1.3 Symbol Definitions

The following table lists those symbols used in this document and on the instrument to denote certain conditions.

Table 1-1: Symbol Definitions

	Direct current
	Chassis terminal
	Caution, risk of electric shock
 WARNING	This symbol indicates a potentially hazardous situation which, if not avoided, could result in death or serious injury.
CAUTION	This symbol indicates a potentially hazardous situation which, if not avoided, may result in property damage.
NOTICE	This symbol indicates important information that must be remembered and aids in job performance.

1.1.4 Organization

Chapter 1, "Introduction", offers general information about the SC Series and this instruction manual.

Chapter 2, "Installation", provides an overview of how to get started quickly if your instrument and transducers were ordered at the same time, or if *Signature Calibration* is used.

Chapter 3, "Operating Modes", discusses the significant features of the SC Series and operation procedures when the instrument is in the INITIALIZE, RUN, ERROR or SETUP modes.

Chapter 4, “Chassis Models”, provides information relating to the hardware chassis such as panel and rack mounting.

Chapter 5, “Options Connector”, contains information about wiring to the 12-pin Options connector to access the Relay Outputs and serial communications.

Chapter 6, “System Menu”, discusses the System Menu which allows you to examine and change settings that affect the operation of the chassis.

Chapter 7, “Serial Communications”, briefly describes RS-232 and RS-485 communications. It also shows how to use the SERIAL COM Menu to examine the settings and test the RS-232 or RS-485 communications.

Chapter 8, “Display Menu”, describes the Display Menu which allows you to change what is shown on the lower line of the instrument’s display.

Chapter 9, “Limits”, discusses how the Limits operate and describes how to alter their settings via the Limit Menus.

Chapter 10, “Strain-Gage Input Channel”, explains how to wire, configure, operate and calibrate the Strain-Gage Input Channel with your transducer.

Chapter 11, “AC/AC-LVDT Input Channel”, explains how to wire, configure, operate and calibrate the AC/AC-LVDT Input Channel with your transducer.

Chapter 12, “High-Level Input Channel”, explains how to wire, configure, operate and calibrate the High-Level Input Channel with your amplified transducer, in-line amplifier, or DC-DC LVDT.

Chapter 13, “Split Display Virtual Channel”, shows how you can display two values from any of the channels in the instrument at the same time.

Chapter 14, “Mathematics Virtual Channel”, describes the flexibility of customer-specific SensoCode programming.

Chapter 15, “Error Messages”, lists error messages that the instrument may display, describes their causes and, where possible, suggests solutions.

Chapter 16, “Setup Menu Reference”, is a list of all SETUP menus and a cross-reference to related information in this instruction manual.

1.2 Related Documents

Customer Information Sheet	<p>Every instrument is shipped with a Customer Information Sheet which documents important information specific to each instrument, such as:</p> <ul style="list-style-type: none">• part number,• date of manufacture,• list of all installed channels and their setup information,• customer specific SensoCode programming of Mathematics Virtual channels and operation notes.
Communications Guide	<p>The “SC Series Communications Guide”, document 008-0610-00, describes in detail how to communicate with an SC Series instrument using RS-232 and RS-485. Wiring diagrams, sample programs, and descriptions of each command are included.</p> <p>A printed copy of this document is available for order, or you may download it from http://www.honeywell.com/sensotec.</p>
Supplemental Instructions	<p>If an instrument is configured with Mathematics Virtual channels, one or more sets of Supplemental Instructions may be included. These instructions contain important information about which indicator lights, Function Input pins and/or Limit Output pins of the System connector are used by the Mathematics Virtual channel.</p>

1.3 What is the SC Series?

The SC Series of Signal Conditioners/Indicators are versatile, multi-channel devices designed to operate with many different types of sensors. Several different chassis types, Input channels, and Output channels are available to allow the configuration of an SC instrument to meet a variety of measurement and control needs. The operation of an SC instrument is based on digital technology to provide improved accuracy, superior ease of setup, and a wealth of features.

1.3.1 Features

The main features of the model SC500 are:

- Alarm limits (optional two or three), with versatile setup
- Automatic setup, calibration, and scaling of strain-gage sensors through the use of *Signature Calibration*TM
- Field selectable, digital, low-pass filtering (“damping”) on each Input channel
- Up to $\pm 50,000$ part resolution
- Field selectable five-, six - or seven-digit (9,999,999 maximum) display
- Optional RS-232 or RS-485 communications
- Push-button on/off tare feature

1.3.2 Chassis Models

This manual covers the following models (i.e. chassis types):

- **SC500:** 1 physical channel, 1/8 DIN case

1.3.3 Channel Types

Channels can be one of two types: Input or Virtual

Input Channel

The Model SC500 always contains a single input channel designated as Channel 01. At the time of order, the input channel can be configured to operate with one of the following types of sensors:

- Strain-gage sensors, such as unamplified pressure transducers and load cells
- Sensors with voltage outputs, such as transducers with the Option 2a, 2b, 2c, 2d, 2g, 2j, 2k, 2p, 2t or 2y internal amplifier
- Sensors with current outputs, such as transducers with the Option 2j, 2k or 2n internal amplifier
- AC-AC LVDTs (Linear Variable Displacement Transducers)
- DC-DC LVDTs

Virtual Channels

Virtual channels are software based devices that occupy a channel number, but not a physical slot, in an instrument.

- Split Display Virtual channels allow the displaying of any two channel's track, peak or valley values at the same time.
- Mathematics Virtual channels run small programs written in an interpretive language called SensoCode. This provides great flexibility which allows the SC Series to do many jobs which otherwise requires a personal computer or PLC.

1.4 What is *Signature Calibration*?

1.4.1 Overview

A small integrated circuit is located either inside the transducer, in an in-line package between the instrument and the transducer, or in the connector of a cable. All data necessary to set up the transducer with the instrument are stored (even linearity data), and setup is automatic when a new transducer is connected to the instrument.

The Strain-Gage Input channel of the SC Series is designed to operate with *Signature Calibration*. It will automatically set itself up with transducers which contain the memory device, but can also be set up using a front-panel interactive procedure. The *Signature Calibration* module can also be programmed from the instrument's front panel.

Signature Calibration is only available with unamplified strain-gage transducers.

1.4.2 Benefits

The benefits are:

- The transducer's Calibration Record is always located where it is needed most... with the transducer.
- The instrument is always set up correctly with the transducer.
- Interchanging of transducers and instruments is a quick process.
- A User Calibration Data area that can be altered by customers to fit their requirements.
- A Factory Calibration Sheet Data area, unalterable by the customer, can be copied back into the User Calibration Data.

1.4.3 Information Stored

The following information is stored inside transducers equipped with *Signature Calibration*:

- Full-scale mV/V: The full-scale millivolt-per-volt (mV/V) rating of the transducer when its full load is applied; also called "calibration factor".
- Shunt-Cal mV/V: The millivolt-per-volt output of the transducer when the shunt calibration resistor is placed across its (-)SIGNAL and (-)EXCITATION leads.
- Shunt Resistance: The resistance value, in Ohms, that was used to obtain the shunt-cal mV/V value above.
- Full-Scale Value: The full scale value of the transducer, in engineering units.
- Engineering Units: The engineering units that the transducer is calibrated in (i.e. pounds, grams, pascals, inches of water, etc.).
- Serial Number: The serial number of the transducer.
- Excitation Voltage: The magnitude and type of signal used to excite the transducer.
- Linearization Points (optional): These can be used by an instrument using Shunt Calibration or Millivolt-per-Volt Calibration to correct any non-linearity in the transducer and thus improve the accuracy of the system. An additional "multiple-point calibration" can be purchased with the transducer that allows linearity correction information to be placed into its *Signature Calibration* module.

2.1 Locate Required Parts and Information

The following items are required to set up an SC Series instrument with your transducer:

- SC Series instrument
- The AC power adapter that shipped with the instrument.
- Transducers that are to be connected to the instrument
- For each transducer to be connected to the instrument, a connecting cable. This cable will have a 12-pin, green, plastic connector on one end and the transducer's mating connector on the other end. Usually, this cable is ordered along with the instrument and transducer. If the connecting cable was not ordered with the instrument, you may need to make this cable.
- The transducer's Calibration Record or Certificate of Calibration.
- The Customer Information Sheet that shipped with your instrument. This sheet describes which cards are installed in each channel.

2.2 Connect the Transducer to the Input Channel

Connect the cable between the transducer and the Input Channel connector on the instrument. The Input Channel connector is the 12-pin connector located on the top, rear of the instrument.

If the instrument and transducer were not purchased with a connecting cable, you may need to make this cable. For the transducer's pin connections, see that transducer's calibration record. For the pin connections for the Input Channel of the instrument, see the appropriate chapter in this manual. For example, if your instrument was purchased with a Strain-Gage Input Channel see the chapter "Strain-Gage Input Channel" on page 51.

2.3 Turn on the Instrument

Connect the power supply between the instrument power source and the instrument.

The instrument enters its INITIALIZE mode that lasts a few seconds per channel. As each channel in the instrument is initialized, the transducer's serial number may be seen on the display if the transducer has a *Signature Calibration* Module in it.

NOTICE

If the channel's display flashes "APPLY 00000." (or some other load value), the instrument has detected a transducer other than the one which was last calibrated with that channel. The instrument is prompting you to apply the requested load to the transducer so that a "mV/V Calibration" or a "Shunt Calibration" can take place.

After making certain that the correct transducer is connected to the Input Channel, press the [ENTER] button after you have applied the requested load to perform the calibration.

NOTICE

If the instrument displays error code 57 or 68, it has detected a transducer other than the one which was last calibrated with the Input Channel. Furthermore, the channel cannot perform an automatic calibration because its calibration type has been set to "Known Load Calibration".

Either re-connect the correct transducer to the channel, or see "CALIBRATION TYPE Menu Item" on page 60 to select another calibration type.

When the instrument enters its normal operating mode (RUN mode), you will see the following format on the front panel display:

```
1. 00000. PSIG "
```

where:

- **Channel number:** "1" is the channel number.
- **Value type:** The next character indicates the nature of the following value. A blank character indicates the tracking value. The instrument is "tracking" the signal, continuously updating the display in response to the signal from the transducer. A "." character indicates the peak value (highest value seen since the [CLEAR] button was last pressed). A "-" character indicates the valley value (lowest value seen since the [CLEAR] button was last pressed).
- **Data value:** "00000." displays the value from the transducer in engineering units.
- **Units label:** "PSIG" indicates the engineering units being used (up to 4 characters).
- **Tare indicator:** A " " symbol indicates tare is off; a "■" symbol indicates tare is on.

2.4 Use the SETUP Menus to Enter Transducer Information

You can skip this step if:

- You are using a transducer equipped with *Signature Calibration*, or
- The transducer and instrument were purchased together and set up by Sensotec.

Otherwise, you must enter information about your transducer into the SETUP menu of the channel to which it is connected. See the appropriate chapter of this manual for that card type.

2.5 Calibrate the Transducer to the Input Channel

You can skip this step if:

- You are using a transducer equipped with *Signature Calibration*, or
- The transducer and instrument were purchased together and set up by Sensotec.

Otherwise, you must choose a calibration method (e.g. Shunt Calibration, mV/V Calibration, or Known Load Calibration) appropriate for your application and use the SETUP menu for the Input Channel (“CHANNEL 01 MENU”) to calibrate the channel to the transducer. See the appropriate chapter of this manual for the input channel type that was purchased with the instrument.

2.6 The SC Series Instrument is Ready for Use

See “RUN Mode” on page 20 for information on how to operate the instrument while it is in the RUN mode.

Apply some test stimulus on the transducer to observe changes in the display.

3.1 Operating Modes

The SC Series instruments have four modes of operation:

- INITIALIZE, to test the instrument upon power up
- RUN, normal operation
- ERROR, which indicates that an abnormal situation has occurred that stopped the operation of the instrument
- SETUP, a menu which allows setup and calibration of the chassis and its channels

Each of these will be described in this chapter.

3.2 INITIALIZE Mode

When the instrument is powered up or otherwise reset, it enters the INITIALIZE mode. As the instrument enters this mode, all segments of the display illuminate momentarily. Next, each channel in the instrument is checked for proper operation.

If a problem is detected, the instrument may enter the ERROR mode.

Depending on the type of channel, other actions may occur. For example, a Strain-Gage channel will calibrate its analog-to-digital converter and attempt to read the transducer's *Signature Calibration* information. If the transducer is equipped with *Signature Calibration*, the transducer's serial number is displayed momentarily.

3.3 RUN Mode

After the INITIALIZE mode finishes, the instrument enters the RUN mode, its normal mode of operation.

3.3.1 Display

Upper line

The display will show a channel number on the far left, followed by the channel's operation messages.

For example, the Strain-Gage Input Channel will use the format below:

```
1• 00000. PSIG "
```

where:

- **Channel number:** "1" is the channel number.
- **Value type:** The next character indicates the nature of the following value. A blank character indicates the display is being continuously updated by "tracking" the input signal to the channel. A "•" character indicates the peak value (highest value seen since the [CLEAR] button was last pressed). A "-" character indicates the valley value (lowest value seen since the [CLEAR] button was last pressed).
- **Data value:** "00000." displays the value from the transducer in engineering units.
- **Units label:** "PSIG" indicates the engineering units being used (up to 4 characters).
- **Tare indicator:** A " " symbol indicates tare is off; a "E" symbol indicates tare is on.

Lower Line

The contents of the display's lower line is selected with the "DISPLAY MENU -> DISPLAY MODE" menu item as either displaying a channel or indicating the status of Limits. See "Indicator Lights" on page 21.

3.3.2 [VALUE] button

After the channel number, the next characters indicate which data value for the displayed channel is shown. There are three (possibly four) data values available from each channel:

- (blank), tracking data value
- "•", peak data value, (highest value since the peak/valley detector was cleared)
- "-", valley data value, (lowest value since the peak/valley detector was cleared)
- "□", percentage of the Analog-to-Digital converter's full-scale digitizing capability. This data value is only available when the channel's "DIAGNOSTICS -> DISPLAY ADC" menu item is set to "ON".

Pressing and releasing the [VALUE] button cycles through the available sources for data values for the displayed channel.

3.3.3 [CLEAR] Button

Pressing and releasing the [CLEAR] button will reset the peak and valley values of the channel being monitored by the display to the track value. Additionally, any limits in the instrument that are "latched" will be reset.

To clear the peak and valley values of the Input Channel regardless of which channel is being monitored by the display, use the AUX1 or AUX2 control pins on the Input Channel connector. See the particular chapter regarding that channel for details.

3.3.4 [CHANNEL] button

If the configuration of the instrument contains more than one channel, the left most characters of the display indicates which channel the display is monitoring. Pressing and releasing the [CHANNEL] button will cause the next channel to be displayed.

If the "DISPLAY MENU -> DISPLAY MODE" menu item is set to "LOWER=CHANNEL", the [CHANNEL]

button cannot be used to change which channel the lower line is monitoring. That is selected with the “DISPLAY MENU -> LOWER CHANNEL” menu item.

Shunt Calibration Check

If the [CHANNEL] button is held down for more than 3 seconds when the display is monitoring the Input Channel (Channel 01), the Input Channel’s shunt calibration function (if the channel has shunt calibration available) will be engaged.



3.3.5 [TARE] button



To reset the channel’s display to zero, press the [TARE] button while in RUN mode. To restore the tare value, press the [TARE] button again. The “Tare” indicator will illuminate when tare is on.

To tare the Input Channel regardless of which channel is being monitored by the display, use the AUX1 or AUX2 control pins on the Input Channel connector. See the particular chapter regarding the type of channel for details.

3.3.6 Indicator Lights

Model SC500

A “” symbol on the right side of a channel’s display indicates tare is off for that channel; a “” symbol indicates tare is on.

If the display is configured with the “DISPLAY MENU -> DISPLAY MODE” menu item as “LOWER=LIMITS”, then the lower line will monitor the status of the Limits. A “” symbol indicates a limit is deactivated; a “” symbol indicates a limit is activated. For example, an instrument with two limits might have the lower line of its display look like this:

L1  L2 

which indicates that Limit 1 is deactivated and Limit 2 is activated. See “DISPLAY MODE Menu Item” on page 43.

NOTICE

These indicators may be overridden by the operation of a Mathematics Virtual channel in custom applications identified at time of order.

3.4 ERROR mode

The instrument enters the ERROR mode when a critical error occurs that prevents the instrument from operating. The display alternates between displaying a two-digit code in the form "ERROR xx ON CH.yy" and a short description of the error. The first two digits "xx" hold the error code. The last two digits, "yy" is channel number that caused the error. For example, "ERROR 60 ON CH.01" indicates that error number 60 occurred on channel 1.

While the instrument is in the ERROR mode, no other operations are taking place except for limited serial communications capabilities. See "Error Message List" on page 128 for a list of error codes and their probable causes.

3.5 SETUP Menu mode

The SETUP Menu mode is used to display or change the settings that control the operation of the instrument.

3.5.1 Available Menus

Each major function of the instrument has its own SETUP Menu. See “Setup Menu Reference” on page 133.

3.5.2 Entering and Exiting the SETUP Menu mode

To enter the SETUP Menu mode, press and hold the [UP] and [DOWN] buttons at the same time until you see “SETUP” on the display. When you release the buttons, you will see the first SETUP Menu item.

3.5.3 Moving Through SETUP Menus and Menu Items

The following table shows how to move through menus and menu items, and how to display or change the setting of a particular item.

Table 3-2: Navigating the Menus

Button	Action
[UP] or [DOWN]	Scroll through available menus, sub-menus or menu items.
[ENTER]	Select a menu, sub-menu or menu item
[EXIT]	If changing a setting: abandons changes to a menu item otherwise: leaves the SETUP mode.

To change the setting of a menu item:

Press [ENTER] to display the current setting, which is preceded by the ‘*’ character. Press [UP] or [DOWN] until you see the setting you want. To abandon changes, press [EXIT]. To accept the new setting and move to the next item, press [ENTER].

3.5.4 Exiting the SETUP Menu mode

To leave SETUP mode and return to the RUN mode, press [EXIT] at any time.

4.1 Single-Input Chassis

The SC Series of Signal Conditioners/Indicators are available in several different chassis models. In general, each chassis model operates in an identical fashion and can be ordered with various configurations of Input channels, Output channels, or Virtual channels. This chapter describes the Model SC500 single-input chassis.

4.1.1 Input Channel

The Model SC500 is a chassis whose small 1/8-DIN form factor allows for a single Input channel identified as “Channel 01”. The type of Input channel installed in the instrument is selected at the time of order. Input channels are available for a wide variety of transducers including strain gage, AC/AC LVDT, RTD and high-level voltage and current inputs. The Input Channel uses a 12-pin connector located at the top, rear of the instrument.

If the DAC (Digital-to-Analog Converter) Output option is selected at the time of order, then two pins of the Input Channel connector will be used for the DAC Output.

4.1.2 Options Board

The Options Board is installed when optional features such as Limits (and their Relay Outputs), DAC Output or RS-232/RS-485 communications are selected at the time of order. The Options Board uses a 12-pin connector located at the bottom, rear of the instrument.

4.1.3 Virtual Channels

A Virtual channel exists in software only; it does not occupy a physical slot inside the instrument’s chassis. There is no rear-panel connector for a Virtual channel. However, a Virtual channel does require a channel number.

4.2 Specifications

Model SC500

GENERAL

# Physical Input Channels	1
# Virtual Channels	3
Case Material	Aluminum

PHYSICAL

Form Factor	1/8 DIN
Mounting	bench, panel or rack

DISPLAY

# Characters/Line	16
# Lines/Display	2
# Displays	1
Display Type	Vacuum Fluorescent

ENVIRONMENTAL

Storage Temperature	-30° C to 90° C
Operating Temperature	5° C to 40° C
Relative Humidity	80% max. for temperatures up to 31° C; decreasing linearly to 50% max. at 40° C
Other	indoor use at altitudes up to 2000 m; Pollution Degree 2; Overvoltage Category II

SPECIAL FEATURES

Limits Quantity	0 standard, 2 optional, 3 optional
Digital control inputs	2

POWER

Power Requirements	10 VDC to 26 VDC @ 1 A max.
AC Wall-Mount Adapter Included	Yes

4.3 Models SC500 Enclosure

4.3.1 External Arrangement The external arrangement of the Model SC500 is given below.

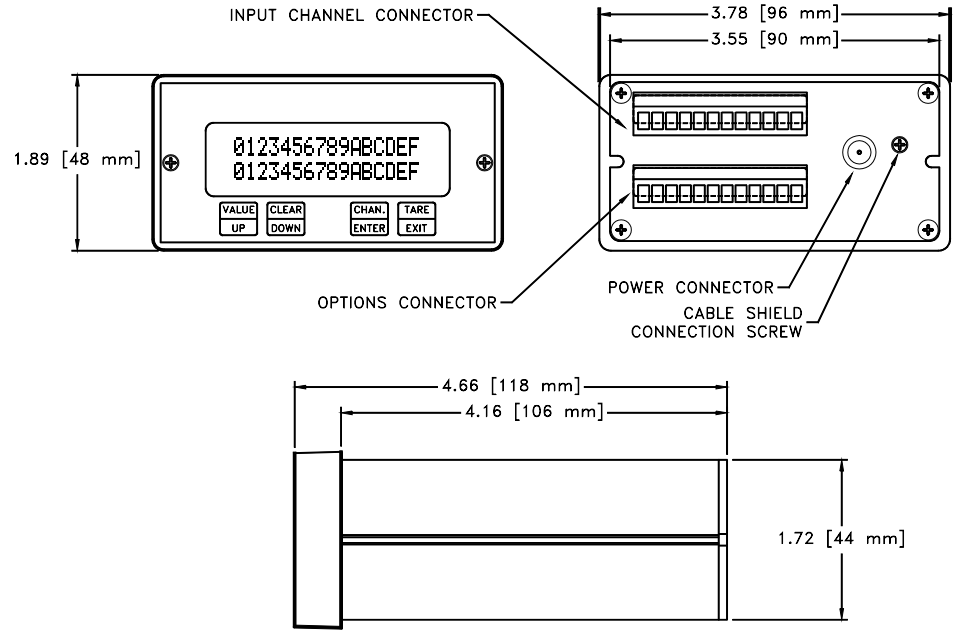

Figure 4-1: External Arrangement of Model SC500

4.3.2 Rear Panel

The pinout for the Input Channel is located in the chapter for that channel's type. The pinout for the Options Channel is located in "Wiring" on page 32.

4.3.3 Panel Mounting

The panel cutout size conforms to the 1/8 DIN standard. Panel-Mounting Jacks (order code AA943) are available that slide into two slots at the sides of the instrument. Use the following procedure to mount a Model SC500 instrument into a panel.

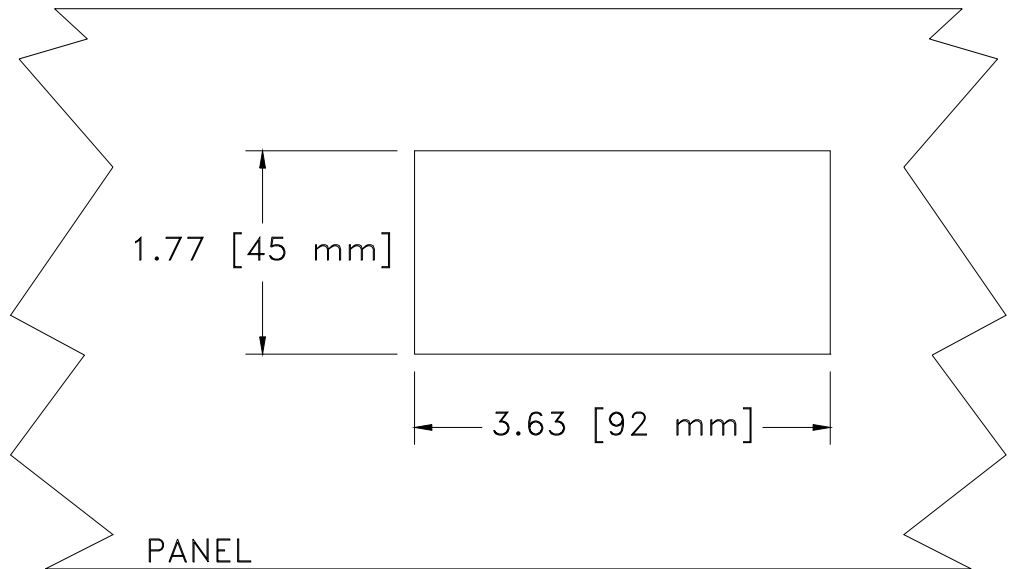

Figure 4-2: Panel Cutout Drawing for Model SC500 (not to scale)

- Step 1. In the panel or rack, cut a hole as shown above. The panel may be up to 1/4" in thickness.
- Step 2. Use an 0.050" Allen wrench to remove two set screws that hold the Panel-Mounting Jacks to the case. To do this, insert the wrench into the side slots at the rear. Remove the screws completely.
- Step 3. Remove the Panel-Mounting Jacks by sliding them toward the rear. If the jacks don't slide easily, tap them gently.
- Step 4. Put the instrument through the hole in the panel.
- Step 5. Reinsert the Panel-Mounting Jacks into the slide slots. Slide them as far toward the panel as possible.
- Step 6. Reinsert the set screws and tighten them. This will force the Panel-Mounting Jacks toward the rear side of the panel, drawing the instrument tightly into place.

4.3.4 Rack Mounting

The following rack mount panels are available to mount Model SC500 instruments into a 19", 2U rack. For each instrument to be mounted into these panels, one set of Panel-Mounting Jacks described above are needed.

- part number 056-0062-00: 19", 2U rack-mount panel for one 1/8-DIN panel meter
- part number 056-0066-00: 19", 2U rack-mount panel for four 1/8-DIN panel meters

4.3.5 Bench Mounting

If bench mounting the instrument, you may want the optional Bench Stand (order code AA924).

4.3.6 Case Removal

⚠ WARNING

Disconnect the power cord and all cables from the instrument before attempting to remove the case.

Failure to comply with these instructions could result in death or serious injury.

CAUTION

Use a #0 Phillips screwdriver on the black screws to avoid damaging them.

Failure to comply with these instructions may result in product damage.

CAUTION

Ensure normal ESD (Electrostatic Discharge) precautions are followed when handling circuit boards.

Failure to comply with these instructions may result in product damage.

Step 1: Remove the cable shield connection screw on the rear of the instrument.

Step 2: Remove the two Phillips-head screws that secure the front panel. **Do not** disconnect the front panel's connecting cable.

Step 3: The front panel and circuit boards will slide out of the front of the case as a unit.

Installation is the reverse of removal.

4.3.7 Internal Arrangement

The figure below shows the names and locations of the printed circuit boards.

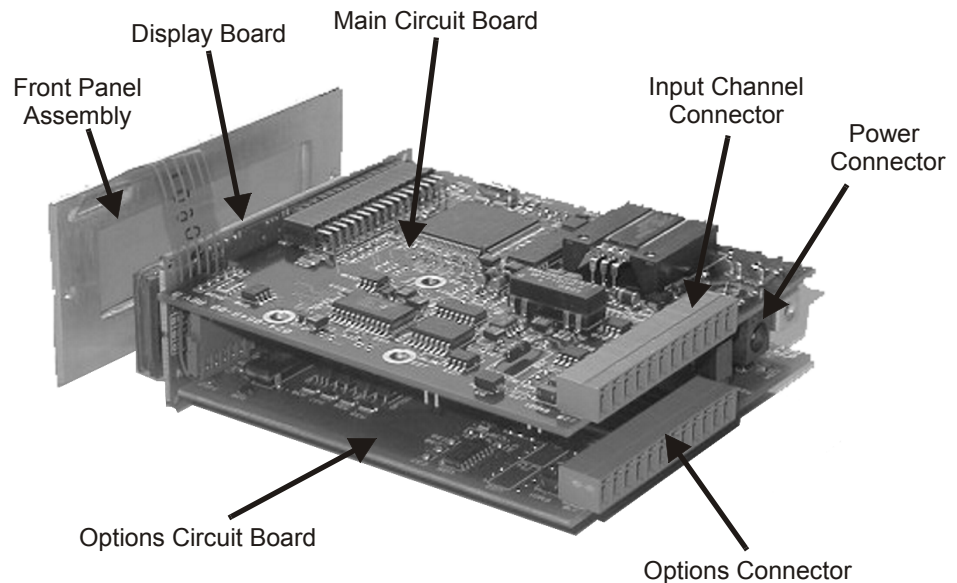

Figure 4-3: Internal Arrangement of Model SC500

4.3.8 Cleaning

CAUTION

Turn off the instrument and unplug all connectors. Do not allow any cleaner inside the instrument.

Failure to comply with these instructions may result in product damage.

Use a soft cloth or tissue and a mild cleaner. Do not use liquid or aerosol cleaners.

4.3.9 Power Connector

The Power connector is for the application of DC power only as specified in “Specifications” on page 26. The Power connector pinout is shown below:

Table 4-3: Power Connector of Model SC500

Pin	Label	Function
tip	+	(+)Supply
ring	-	(-)Supply



Figure 4-4: Power Connector of Model SC500

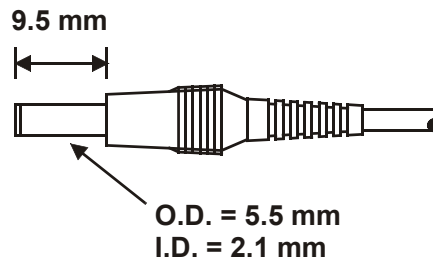

Figure 4-5: Mating Plug for Model SC500 Power Connector

If the instrument will be powered by a DC power supply instead of the wall-mount AC power adapter, a mate for the Power connector may be purchased by part number 023-0769-01.

4.3.10 Wall-Mount AC Power Adapter

Only the specified wall-mount AC power adapter (order code AA961) should be used. This universal wall-mount power supply includes interchangeable plugs for use in the Americas, Europe, the United Kingdom and Australia.

Chapter 5

Options Connector

5.1 Introduction

The 12-pin Options connector is the bottom connector of the instrument's rear panel and is used for the following:

- Communication by RS-232 or RS-485
- Relay Outputs which are used by the optional limits

To determine which options have been factory installed into the instrument, examine the "order code" field of the instrument's serial number tag.

5.2 Accessories

The following connectors and cable assemblies for use with the Options connector are available for purchase. For cable assemblies, the standard length is given but other lengths may be available; consult Honeywell Sensotec for further information.

Table 5-4: Accessory Connectors and Cable Assemblies for Option connector

Order Code	First Connector Description	Number of Wires / Standard Length	Second Connector Description
AA144	12-pin mate for Options connector	12 5m [15 ft]	pigtails
AA145	pigtails	4 2m [6 ft]	9-pin female D-sub
023-0174-00	12-pin mate for Options connector	N/A	N/A

5.3 Wiring

The Options connector is the bottom connector on the instrument's rear panel. To determine which options have been factory installed into the instrument, examine the "order code" field of the instrument's serial number tag.

The RS-232 / RS-485 communications pins are electrically isolated from the rest of the instrument.

5.3.1 2 Form C Relays Option

Table 5-5: Options Connector with Option 58a (2 Form C Relays)

Pin	Label	Function	Reference Pin	Availability
1 (left)	OUT/+TX	RS-232 Data Out (Option 53a) RS-485 Transmit + (Option 53d)	5	Option 53a or 53d
2	IN/-TX	RS-232 Data In (Option 53a) RS-485 Transmit - (Option 53d)	5	Option 53a or 53d
3	DSR/+RX	RS-232 Data Set Ready (Option 53a) RS-485 Receive + (Option 53d)	5	Option 53a or 53d
4	-RX	RS-485 Receive -	5	Option 53d
5	GND	RS-232/RS-485 reference	-	Option 53a or 53d
6	N/C	No Connection	-	
7	RELAY1 NC	Relay 1 normally closed	8	Option 58a
8	RELAY1 COM	Relay 1 common	-	Option 58a
9	RELAY1 NO	Relay 1 normally open	8	Option 58a
10	RELAY2 NC	Relay 2 normally closed	11	Option 58a
11	RELAY2 COM	Relay 2 common	-	Option 58a
12 (right)	RELAY2 NO	Relay 1 normally open	11	Option 58a

**5.3.2 3 Form A Relays
Option**

Table 5-6: Options Connector with Option 58h (3 Form A Relays)

Pin	Label	Function	Reference Pin	Availability
1 (left)	OUT/+TX	RS-232 Data Out (Option 53a) RS-485 Transmit + (Option 53d)	5	Option 53a or 53d
2	IN/-TX	RS-232 Data In (Option 53a) RS-485 Transmit - (Option 53d)	5	Option 53a or 53d
3	DSR/+RX	RS-232 Data Set Ready (Option 53a) RS-485 Receive + (Option 53d)	5	Option 53a or 53d
4	-RX	RS-485 Receive -	5	Option 53d
5	GND	RS-232/RS-485 reference	-	Option 53a or 53d
6	N/C	No Connection	-	
7	RELAY3 COM	Relay 3 common	-	Option 58h
8	RELAY3 NO	Relay 3 normally open	7	Option 58h
9	RELAY1 COM	Relay 1 common	-	Option 58h
10	RELAY1 NO	Relay 1 normally open	9	Option 58h
11	RELAY2 COM	Relay 2 common	-	Option 58h
12 (right)	RELAY2 NO	Relay 2 normally open	11	Option 58h

5.4 Relay Output Pins

5.4.1 Operation

When one of the Limits is activated, the corresponding Relay NO pin on the Options connector will be connected to the corresponding Relay COM pin.

NOTICE

A SensoCode program running on a Mathematics Virtual Channel may override the default behavior of the relay outputs. Consult the Customer Information Sheet included with your instrument for details.

5.4.2 Specifications

RELAY OUTPUT

Quantity and Type	2 form C (Option 58a) or 3 form A (Option 58h)
Contact Rating	0.5A @ 50VAC max. 1A @ 30VDC max.

5.4.3 Diagnostics

See “DIAGNOSTICS Sub-Menu” on page 35 for information on how to manually activate and deactivate each of relay pins from the SETUP Menu.

6.1 Overview

The System menu allows you to examine and change settings that affect the chassis of the SC instrument. You can view the internal software revision and the instrument's configuration (i.e. what type of input channel is installed as Channel 01.).

Detailed instructions on operating the SC instrument in the SETUP Menu mode can be found in "SETUP Menu mode" on page 23. A diagram of all menus is located in the "Setup Menu Reference" on page 133.

6.2 Menu Items

6.2.1 SOFTWARE REVISION Menu Item

This displays the software part number and revision that is resident in the instrument.

6.2.2 CONFIGURATION Sub-Menu

When selected, a sub-menu is displayed which lists all available channels in an SC Series instrument. By pressing [ENTER] when a channel number is displayed, the card type installed in that channel is shown. If a card is not installed in that channel, the message "NOT INSTALLED" is shown. Press [ENTER] again to return to the sub-menu listing of all channels.

6.2.3 DIAGNOSTICS Sub-Menu

This sub-menu allows exercising of the Option connector's Limit Output pins and monitoring of the Input Channel's Auxilliary Input pins.

LIMIT OUTPUT n Menu Items

These menu items are used to select a Limit Output to activate or deactivate. The Limit Outputs are updated immediately.

If the instrument was not purchased with any Limit Outputs, then these menu items do not have any effect.

AUX INPUT TEST Menu Item

When this item is selected, the status of the Auxilliary Function digital inputs on the Input Channel connector are continuously scanned and displayed. A "0" means that an Auxilliary Function pin (labeled as "AUX1" or "AUX2" on the Input Channel's connector) is not connected to the (-)Signature pin (labeled as "-MEM"). A "1" means that these pins are connected (asserted).

Press any button to exit this operation.

SCAN TIME Menu Item

When selected, this menu item displays the time, in seconds, that it last took for the chassis to service all of the channels. In the RUN mode, the chassis reads each channel's track, peak and valley value sequentially. After each channel has been serviced, the limits are processed.

The value displayed is obtained from the last execution of the RUN mode prior to entering the SETUP menu mode. If you enter the SETUP mode immediately after power up, the display will read "NOT AVAILABLE".

6.2.4 INSTALL CHANNEL Menu Item

This menu item will add a Virtual channel as the next highest channel number in the system.

NOTICE

Installing a channel will cause it to use the “default” or “empty” configuration information for that channel. All other channels are unaffected.

Any calibration data, SensoCode mathematics programs, display setup, or other information for that channel will be erased to default values.

Virtual Channel Installation Procedure

Use the following procedure to install a Virtual Channel:

- 1) Enter the SETUP menu mode, then select “SYSTEM MENU -> INSTALL CHANNEL”. The instrument will then present a menu of card types available for installation.
- 2) Select the card type of the card you wish to install. After you select the card type to be installed, you are asked “ARE YOU SURE?”. To cancel this operation, select “NO” or press the [EXIT] button. If “YES” is selected, “WORKING...” is displayed and the installation will commence.
- 3) If the installation was successful, “DONE” will be displayed. If the installation failed, you will see one of the following messages:

“CAN’T INSTALL”: There is no more memory available for Virtual channels.

“SYSTEM IS FULL”: There are no unused channels available in the instrument.

After installing a Mathematics Virtual channel, you must re-load the SensoCode program into the channel with a computer running the “SensoCom Instrument Utility Software”. See “Mathematics Virtual Channel” on page 119 for more information.

6.2.5 DELETE CHANNEL Menu Item

This menu item will delete the last channel in the instrument. Before deletion occurs, the number of the channel to be deleted is displayed and you are asked "ARE YOU SURE". To cancel this operation, select "NO" or press the [EXIT] button. If "YES" is selected, the last channel in the system will be deleted.

NOTICE

Deleting Channel 01 will cause all of the Input Channel's calibration information to be lost.

6.2.6 DEFAULT CHANNEL Menu Item

This menu item will reset all settings for the channel you select to their factory default values. Before the channel settings are reset, you are asked "ARE YOU SURE?". To cancel this operation, press the [EXIT] button. If "YES" is selected, the channel's settings will be reset.

NOTICE

Defaulting a channel is an operation that cannot be undone. All calibration information and other settings will be erased.

7.1 Overview

Serial communications is only available if the instrument was purchased with Option 53a (RS-232) or 53d (RS-485).

The SC Series instruments are designed to communicate with a remote computer system or terminal for the purpose of transferring data values from the instrument to the remote system. The remote computer or terminal also can control many of the functions performed by the instrument.

This chapter explains the SETUP Menu items relating for serial communications. A separate instruction manual is available to assist with the hookup and wiring for data communications as well as provide detailed information of all the available commands. Ask for manual 008-0610-00, "SC Series Communications Guide" or download it from <http://www.honeywell.com/sensotec>.

7.2 Wiring

The Options connector on the instrument's rear panel is used, among other things, for serial communications. See "Options Connector" on page 31 for wiring information.

All of the serial communications pins have 500V of electrical isolation from all other pins and connectors on the instrument. Additionally, all serial communications pins are protected against electrostatic discharge (ESD).

7.3 Communications Protocol

7.3.1 RS-232 vs. RS-485

SC Series instruments are available with either of two communications protocols, RS-232 or RS-485. Only one of these can be installed at a time at the factory.

- RS-232 provides for only one receiver and transmitter per loop, and a loop length of no more than 50 feet.
- RS-485 allows up to 32 devices per loop, and a loop length of no more than 4000 feet. All devices receive messages in parallel on the line, the so-called “multi-drop” system. To avoid garbled transmissions, only one device should respond to a particular message. Therefore, every device on the loop must have a unique address.

If you have an instrument with more than one channel, transmission must be addressed to the appropriate channel within the instrument.

7.3.2 Parameters

All SC instruments use no parity, 8 data bits, and 1 stop bits (“N,8,1”) for serial communications. Baud rates available are 300, 600, 1200, 2400, 4800, 9600, 19200 and 38400. As shipped from the factory, all instruments are set at 9600 baud. The baud rates can be selected through the front panel.

7.4 Serial Com Menu

7.4.1 Overview

The Serial Com menu allows you to examine and change the settings for serial communications as well as test the communications link.

Detailed instructions on operating the SC instrument in the SETUP Menu mode can be found in "SETUP Menu mode" on page 23. A diagram of all menus is located in "Setup Menu Reference" on page 133.

7.4.2 INTERFACE Menu Item

This menu item indicates which serial communications interface is installed in the instrument: "RS-232" or "RS-485".

7.4.3 ADDRESS Menu Item

This allows you to examine and change the two-character address that the instrument will respond to. The default address of "00" (ASCII codes decimal 30, decimal 30).

7.4.4 BAUD RATE Menu Item

This allows you to examine and change the baud rate that the instrument uses for serial communications. The default baud rate is 9600.

7.4.5 AUTO LINE-FEED Menu Item

This allows you to examine the setting (on/off) of the auto line-feed function. When set to "on", a line-feed character (ASCII code decimal 10) is transmitted just before the carriage return (ASCII code decimal 13) that signifies the end of the instrument's response.

If the instrument is connected to a dumb terminal or printer, inserting a line feed before the carriage return will make each message sent by the instrument appear on a separate line and thus be easier to read.

The default setting is "on".

7.4.6 TRANSMIT TEST Menu Item

When this menu item is selected, the instrument immediately transmits the message "ADDRESS nn TEST" where "nn" is the two-character address of the instrument. Then the message "MESSAGE SENT" is shown on the display. This helps detect wiring or other problems with serial communications from the instrument to the computer or PLC.

7.4.7 LEAVE MENU Menu Item

When this menu item is displayed, press [ENTER] to leave this menu. Press [EXIT] to return to the RUN mode.

8.1 Overview

The Display menu allows you to examine and change settings that affect the operation of the display of the SC instrument. You can change which channel is displayed when the instrument is powered-up and what information is shown on the lower line of the display.

Detailed instructions on operating the SC instrument in the SETUP Menu mode can be found in "SETUP Menu mode" on page 23. A diagram of all menus is located in the "Setup Menu Reference" on page 133.

8.2 Menu Items for Model SC500

This instrument has a dual-line display which consists of an upper line and a lower line.

8.2.1 UPPER CHANNEL Menu Item

Specifies the channel that is displayed on the upper line when the instrument is powered-up.

To change whether the channel's track, peak or valley data value is displayed on power-up, use the channel's "OPERATION -> POWER-ON SOURCE" menu item.

8.2.2 LOWER CHANNEL Menu Item

Specifies the channel that is displayed on the lower line when the "LOWER MODE" menu item is set to "CHANNEL".

To change whether the channel's track, peak or valley data value is displayed on power-up, use the channel's "OPERATION -> POWER-ON SOURCE" menu item.

8.2.3 DISPLAY MODE Menu Item

Determines what information appears on the display and how it appears. The choices are:

- "LOWER=BLANK" means that nothing is displayed on the lower line of the display. This is an example:

```
1. 00000. PSIG "
```

- "LOWER=LIMITS" means that the status of the Limits are displayed as described in "Indicator Lights" on page 21. This is an example:

```
1. 00000. PSIG "  
L1 " L2 "
```

- "LOWER=CHANNEL" means that the channel specified with the "LOWER CHANNEL" menu item is displayed. This is an example:

```
1. 00000. PSIG "  
1. 00000. PSIG "
```

- "UPPER=LARGE" means that the channel specified with the "UPPER CHANNEL" menu

item is displayed in a large font that spans the upper and lower lines of the display. In this mode, the setting of the "LOWER CHANNEL" menu item is not used by the instrument. This is an example:



8.2.4 LEAVE MENU Menu Item

When this menu item is displayed, press [ENTER] to leave this menu. Press [EXIT] to return to the RUN mode.

9.1 Understanding Limits, Set Points and Return Points

Limits are only available if the instrument was purchased with Option 58a or 58h.

Limits are signal levels at which some action (such as a light to come on or go out, or a switch to close) is desired to take place. The point at which this action takes place is the *SET POINT*. The *RETURN POINT* is the point at which the action that took place at the *SET POINT* returns to its original state.

If the *SET POINT* and *RETURN POINT* are identical and the signal level is changing slowly near these points, “chatter” may result and the limit rapidly energizes and de-energizes. To keep this from happening, we can specify the *SET POINT* at which the action would occur as well as the *RETURN POINT* where we want the action to cease. If the amount of “dead band” between these two values is more than the expected noise, the desired action will take place only once. The *SET POINT* and the *RETURN POINT* should always be separated to insure that small amounts of noise on the signal will not become a problem.

A good general rule for *SET POINT* and *RETURN POINT* values is that they should be separated by at least one percent of the full-scale value.

9.2 Wiring

Unless overridden by a application-specific SensoCode program, the Limits drive the Relay pins of the Options connector. See “Options Connector” on page 31 for details.

9.3 Limit Operation

9.3.1 Actions When Activated

When one of the Limits are activated, the following actions occur:

- The front panel indicator on the display will illuminate.
- The Relay corresponding to the Limit will activate.

9.3.2 Scan Time

The “scan time” or update rate of the limits depends on how many channels are installed in the instrument. To determine the scan time of the limits for your particular instrument, see “SCAN TIME Menu Item” on page 35.

9.4 Limit Menus

9.4.1 Overview

There are zero, two or three Limit menus depending on how many Limits were purchased with the instrument. These menus determine the operation of each of the limits.

Detailed instructions on operating the instrument in the SETUP Menu mode can be found in "SETUP Menu mode" on page 23. A diagram of all menus is located in "Setup Menu Reference" on page 133.

9.4.2 LIMIT. ENABLE Menu Item

This enables or disables the operation of this limit. The two options for this menu item are "ON" and "OFF".

9.4.3 LIMIT. SETPOINT Menu Item

This is the numeric value in engineering units for the signal level that activates the limit.

9.4.4 LIMIT. RETURN PNT Menu Item

This is the numeric value at which the limit deactivates. In general, this number should differ from the set point values by at least 1% of full scale.

Carefully consider what value should be entered for the *RETURN POINT*. If the signal is expected to approach the *SET POINT* from a lower value, the *RETURN POINT* value should be less (algebraically) than the *SET POINT*. If the signal is expected to approach the *SET POINT* from a higher level, the *RETURN POINT* should be higher (algebraically) than the *SET POINT*.

9.4.5 LIMIT. ENERGIZE Menu Item

This specifies when to activate the limit relative to the set point and return point.

The options for this menu item are:

- "SIGNAL > SETPOINT" means the limit will activate when the signal is higher than the set point.
- "SIGNAL < SETPOINT" means the limit will activate when the signal is lower than the set point.
- "SIGNAL INSIDE" means the limit will activate when the signal is in between the set point and the return point.
- "SIGNAL OUTSIDE" means the limit will activate when the signal is not in between the set point and the return point.

The figures below further illustrate the differences between these settings.

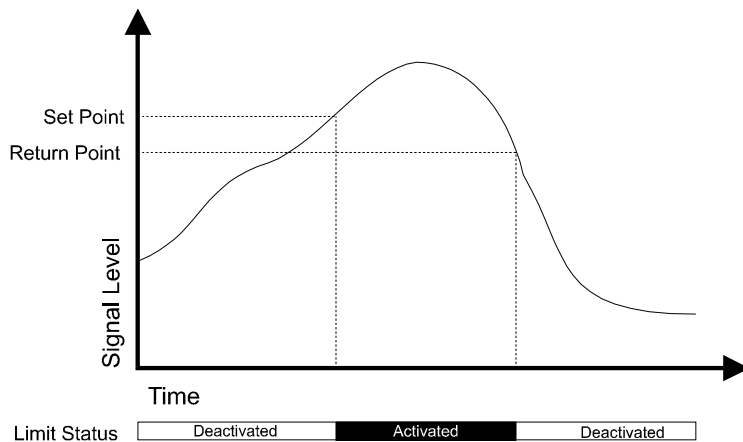

Figure 9-1: Limit Operation when `LIMIT. ENERGIZE = SIGNAL > SETPOINT`

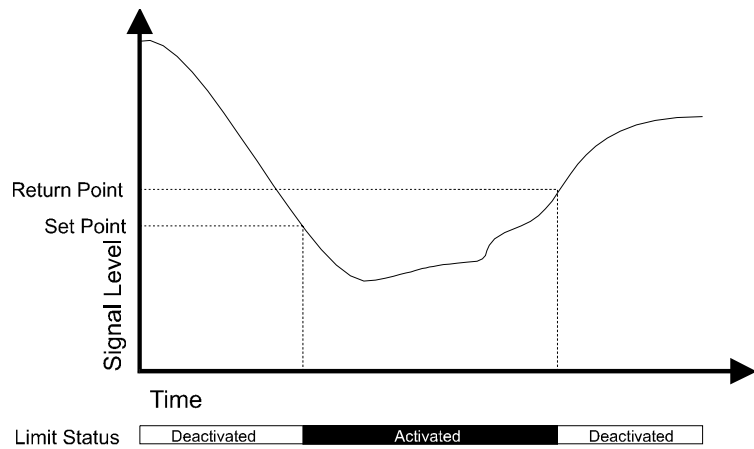

Figure 9-2: Limit Operation when $LIMIT.ENERGIZE = SIGNAL < SETPOINT$

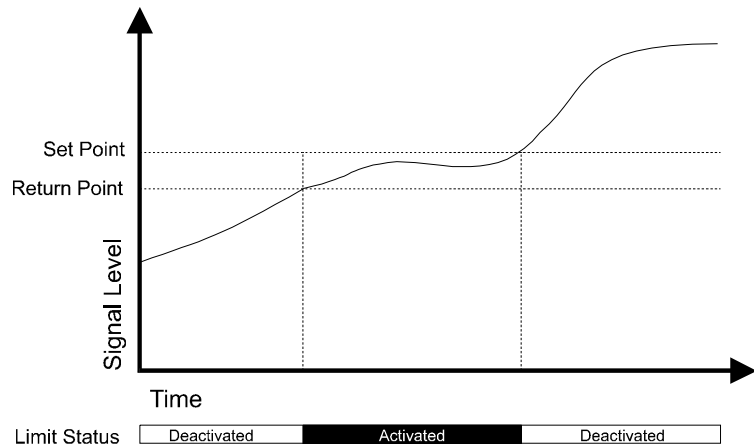

Figure 9-3: Limit Operation when $LIMIT.ENERGIZE = SIGNAL$ INSIDE

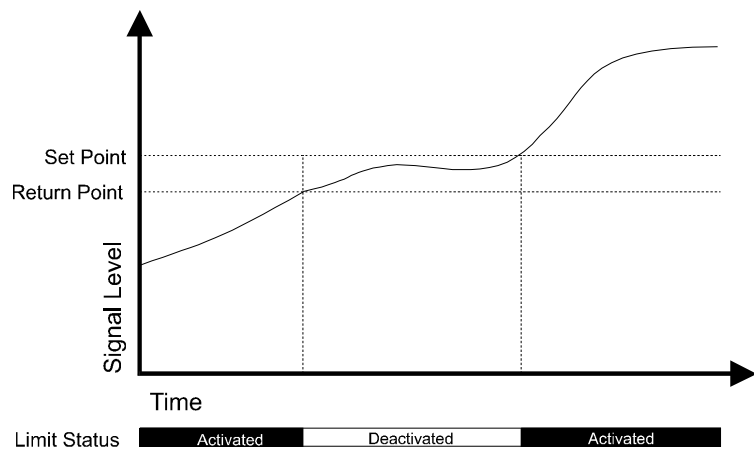

Figure 9-4: Limit Operation when $LIMIT.ENERGIZE = SIGNAL$ OUTSIDE

9.4.6 LIMIT, LATCHING Menu Item

This specifies whether to latch the activated limit so that only manually clearing the limit will deactivate it. A latched limit can be manually cleared by pressing the [CLEAR] button or sending the "F8" serial communications command.

The options for this menu item are:

- "ON" means that once a signal activates the limit, the limit will remain activated until it is reset.
- "OFF" means that the limit will deactivate immediately when the signal crosses the return point.

9.4.7 LIMIT, CHANNEL Menu Item

This specifies the channel that is monitored by this limit.

9.4.8 LIMIT, SOURCE Menu Item

This designates the data source of the channel monitored by this limit. Each channel has three data sources: the live tracking value (TRACK), its highest value (PEAK), and its lowest value (VALLEY).

The options for this menu item are:

- "TRACK" means the live tracking value of the channel.
- "PEAK" means the highest value of the channel since the peak/valley detector was last cleared.
- "VALLEY" means the lowest value of the channel since the peak/valley detector was last cleared.

9.4.9 LEAVE MENU Menu Item

When this menu item is displayed, press [ENTER] to leave this menu. Press [EXIT] to return to the RUN mode.

10.1 Features

The Strain-Gage Input channel provides a DC excitation voltage to and accepts millivolt signals from strain-gage transducers. These millivolt signals are digitized, converted into engineering units, and placed into the track, peak and valley data values of the channel. Setup and calibration of the channel can be made manually through the SETUP mode or automatically if the transducers are equipped with *Signature Calibration*. See “What is Signature Calibration?” on page 13.

The analog-to-digital converter input circuit, features adjustable digital, low-pass filtering, 12- to 18-bit resolution (depending on the filter setting) and has several different mV/V input ranges. These many input ranges allow $\pm 50,000$ count resolution (at the slowest filter setting) across a wide variety of mV/V input ranges.

Three methods of calibrating the Strain-Gage Input channel to the transducer are available: known-load calibration, shunt calibration and mV/V calibration. The benefits of each are discussed in “CALIBRATION TYPE Menu Item” on page 60.

Two rear panel control inputs can be field-configured for such functions as remote tare, disabling peak/valley detection and clearing the peak/valley values. A voltage or current digital-to-analog (DAC) output is also available as an option.

Many diagnostic functions are performed automatically to insure correct wiring and operation of the transducer.

10.2 Wiring

Connect the transducer to a Strain-Gage Input channel by wiring it to the Input Channel connector (the top connector on the instrument's rear panel). The Customer Information Sheet that shipped with the instrument describes which cards are installed in each channel. The pin-out for this connector is shown on the following table.

Table 4-7: Strain-Gage Input Channel Pin Connections

Pin	Label	Function	Reference Pin	Availability
1 (left)	+EXC	(+)Excitation	10	standard
2	SHUNT1	Shunt Relay	3	standard
3	SHUNT2	Shunt Relay	2	standard
4	+EXC	(-)Excitation	10	standard
5	+SIG	(+)Signal	10	standard
6	-SIG	(-)Signal	10	standard
7	+OUT	DAC Output	8	Option 58i
8	-OUT	DAC Return	-	Option 58i
9	+MEM	(+)Signature	10	standard
10	-MEM	(-)Signature / Digital Ground	-	standard
11	AUX1	Auxiliary Function 1 (connect to pin 10 to activate)	10	standard
12 (right)	AUX2	Auxiliary Function 2 (connect to pin 10 to activate)	10	standard

The DAC Output and DAC Return pins are only available with Option 58i and are electrically isolated from all other pins on the instrument.

10.2.1 Strain-Gage Transducers

Use the following wiring diagram when connecting an unamplified, strain-gage transducer to a Strain-Gage Input channel.

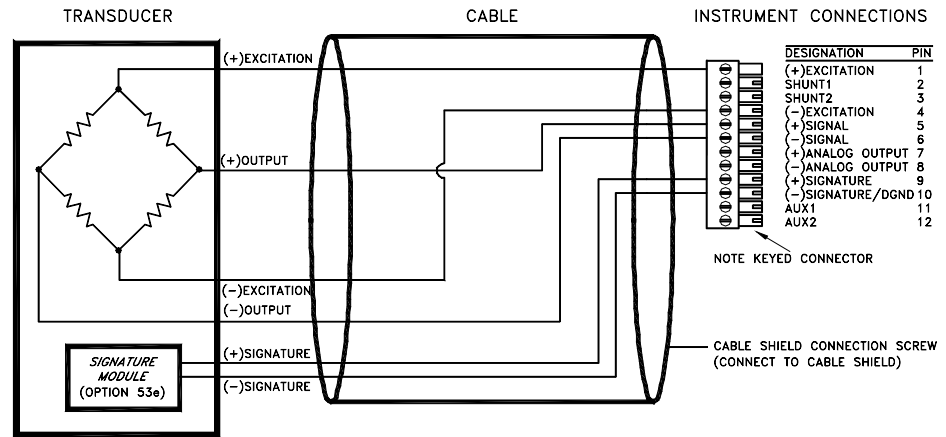

Figure 10-1: Unamplified Transducer Connection to Strain-Gage Input Channel

If the Shunt Calibration method is used to calibrate the instrument to the transducer, the shunt calibration resistor inside the instrument is placed across the (-)Excitation and (-)Output pins during Shunt Calibration functions. Normally, the instrument has a shunt calibration resistor of 59000 (59K) ohms installed. The shunt resistor's ohmic value used to generate the Shunt-Calibration Output is given on the transducer's Certificate of Calibration. If your transducer and instrument were purchased at the same time, the correct shunt resistor for your transducer has been installed.

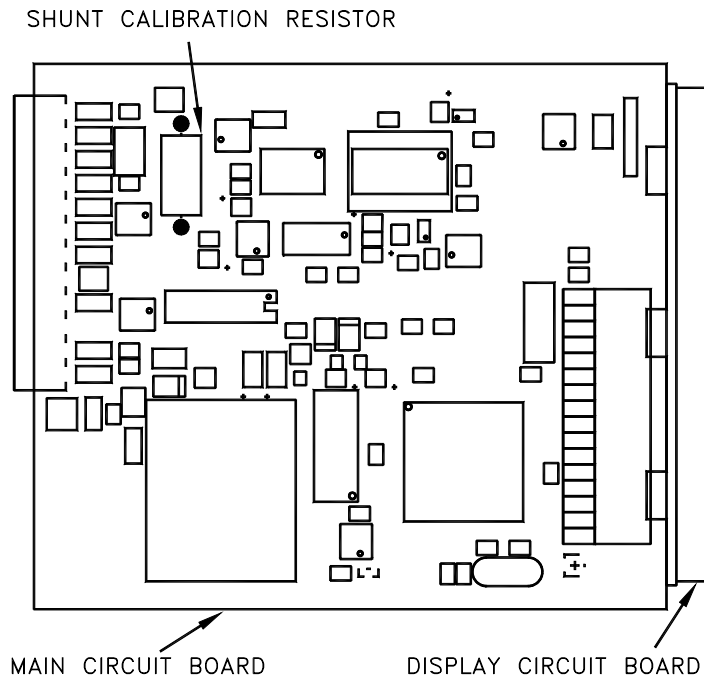

Figure 10-2: Shunt Calibration Resistor Location

10.2.2 Strain-Gage Transducers with Buffered Shunt Cal

Some strain-gage transducers with mV/V output include a “buffered shunt calibration” feature. Connecting the transducer’s Shunt Cal pin to its (-)Excitation pin, activates its shunt calibration function. Transducers with this feature include:

- Model FP2000 pressure transducer with Options 2u and 3d

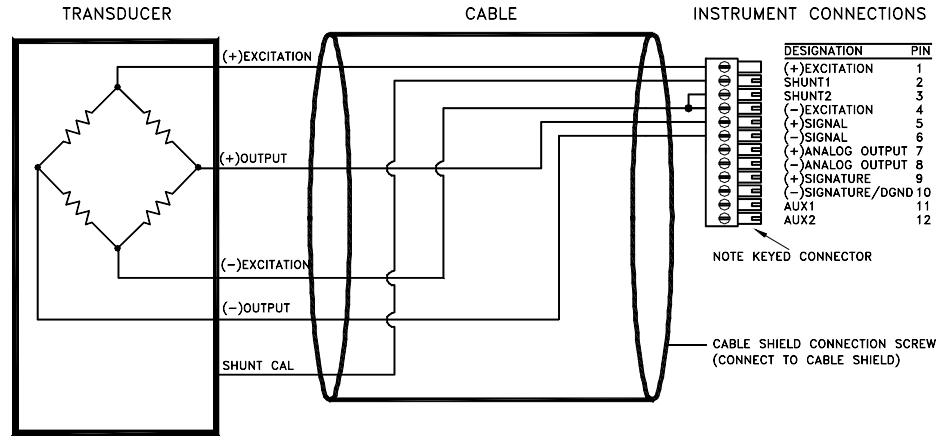

Figure 10-3: Transducer w/Buffered Shunt Cal Connection to Strain-Gage Input Channel

To use the transducer’s buffered shunt cal feature, the instrument must be configured to connect the SHUNT1 and SHUNT2 pins of the Input Channel connector when the shunt cal feature is needed. If transducer and instrument were purchased together, the instrument was configured for the correct Shunt Cal Application configuration.

Table 4-8: Shunt Cal Application Configuration

Does transducer have “buffered shunt cal” feature?	Instrument’s internal Shunt Cal Resistor (see “Figure 10-2:” on page 53)	Jumper Block J24		
		pins 1 & 2	pins 3 & 4	pins 5 & 6
no	installed	open	open	closed
yes	removed	closed	closed	open

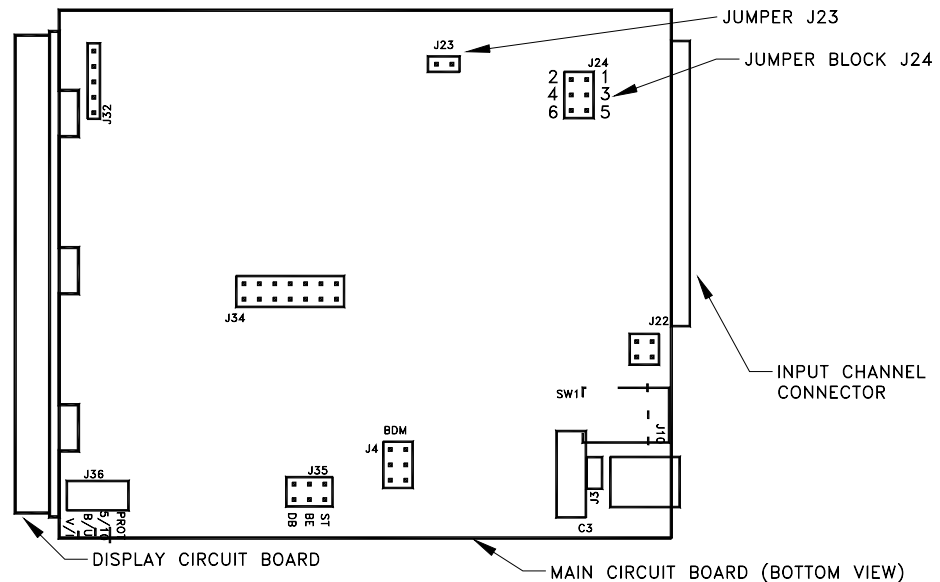

Figure 10-4: Location of Shunt Cal Application Jumpers

10.3 Calibration Procedure

If you are not familiar with operating the instrument in the SETUP menu mode, see “SETUP Menu mode” on page 23. A listing of all menu items is given in “Setup Menu Reference” on page 133.

Step 1: Wire the transducer to the channel’s connector.

See “Wiring” on page 52 for details.

Step 2: Enter the CALIBRATION TYPE.

There are three methods that can be used to calibrate the transducer to the Input Channel. Each has advantages and disadvantages as described in “CALIBRATION TYPE Menu Item” on page 60. It is important to know your application in order to select the appropriate calibration type.

Step 3: Enter the CALIBRATION DATA.

If your transducer has *Signature Calibration*, you don’t need to enter these values as they are entered automatically.

If your transducer was ordered and shipped along with the instrument, you don’t need to enter these values as they have been entered at the factory.

Otherwise, consult the Certificate of Calibration for the transducer when entering information in the CALIBRATION DATA sub-menu.

Step 4: Perform the calibration.

Otherwise, use the CALIBRATE menu item to start the calibration process. You will be prompted to apply loads to the transducer as required.

10.4 Specifications

TRANSDUCER INPUT

Transducer type	full-bridge, strain gage
Excitation Supply	5 VDC @ 60 mA max.
Excitation Overcurrent Protection	yes
Transducer full-scale output	0.5 mV/V to 21.0 mV/V
Amplifier Gain Selection	automatic
Calibration Type	shunt, mV/V or 2-, 3- or 5- point known load
Differential Input Voltage	+/- 105 mV (max.)
A/D Converter	24-bit Sigma-Delta
Low-pass filter	digital, 24-tap FIR
Resolution and Frequency Response	see "FREQ. RESPONSE Menu Item" on page 57

INSTRUMENT-ONLY ACCURACY

(Frequency Response setting ≤ 16Hz; Linearity, repeatability & hysteresis)

mV/V Calibration	±0.1% F.S.
Known Load Calibration	±0.01% F.S.

AUXILLIARY INPUTS

Quantity	2
Type	momentary contact closure
Response Time	< 5ms
Field-Selectable Functions	tare on, tare off, peak/valley clear, peak/valley hold, track hold

DIGITAL-TO-ANALOG OUTPUT

Availability	with Option 58i
Output voltage range	5, ±5, 10 or ±10 VDC (field selectable)
Source	any channel's track, peak or valley value
Isolation	500V
Resolution	14 bits
Frequency Response	same as input when driven by the same channel's tracking data

10.5 Channel Menu

Each Strain-Gage Input channel is configured and calibrated via its channel menu. Detailed instructions on operating the instrument in the SETUP Menu mode can be found in "SETUP Menu mode" on page 23. A diagram of all menus is located in "Setup Menu Reference" on page 133.

10.5.1 OPERATION Sub-Menu

This menu controls the operation of this channel when the instrument is in the RUN mode.

AUTO-ZERO Menu Item

This enables or disables the channel's automatic zeroing function. The auto-zero function can be beneficial by removing the effect of slight temperature shifts in the transducer's output. The two options for this menu item are "ON" and "OFF".

When enabled, the channel will reset its tracking value to zero when the tracking value has never been more positive than +10 or more negative than -10 display counts for any 10 second period.

For example, assume that the DISPLAY.DECPT menu item is set to 000.00 (two decimal points). If the tracking value never leaves the range of -000.10 to +000.10 for any 10 second period, then tracking value will reset to 000.00 automatically.

NOTICE

To compensate for the transducer's initial warm-up shift, the auto-zero function operates every 2 seconds during the first 60 seconds of RUN mode operation.

FREQ. RESPONSE Menu Item

This sets the frequency response, step response, and resolution of the channel according to the table below. The tracking value, peak/valley detector values and DAC Output are all affected. The default value of 016. HERTZ is suitable for most applications.

Frequency Response	Step Response (ms) (typical)	Resolution (counts) (not including min. 10% overrange/underrange capability)
002. HERTZ/FAST	40	±50000
002. HERTZ	440	±50000
008. HERTZ	110	±25000
016. HERTZ	55	±20000
032. HERTZ	28	±10000
050. HERTZ	16	±5000
100. HERTZ	8	±5000
250. HERTZ	3	±2000

POWER-ON SOURCE Menu Item

This menu selects which value is displayed by the channel when first entering the RUN mode. The choices are:

- "TRACK" means the live tracking value of the channel.
- "PEAK" means the highest value of the channel.
- "VALLEY" means the lowest value of the channel.

10.5.2 DISPLAY SETUP Sub-Menu

This menu controls how data values are displayed by the channel and transmitted via serial communications.

DISPLAY. DIGITS Menu Item

Selects the number of digits displayed by the channel. The choices are:

- “5 DIGIT-BIPOLAR” displays both positive and negative numbers with five full digits (± 99999).
- “6 DIGIT-UNIPOLAR” displays positive numbers with six full digits (999999) and negative numbers with five full digits (-99999).
- “7 DIGIT UNIPOLAR” displays positive number with seven full digits (9999999) and negative numbers with six digits (-999999).

This menu item may be automatically updated by a transducer’s *Signature Module*.

DISPLAY. DECPY Menu Item

Selects the decimal point location on the channel’s display and serial communications output. Use the [UP] and [DOWN] buttons to move the decimal point to the right and left.

This menu item may be automatically updated by a transducer’s *Signature Module*.

DISPLAY. COUNT-BY Menu Item

Determines by what value the display increments or decrements. This will make the display less sensitive to a noisy signal. The choices are:

- “00001”
- “00002”
- “00005”
- “00010”
- “00020”
- “00050”
- “00100”
- “00200”

This menu item may be automatically updated by a transducer’s *Signature Module*.

DISPLAY. UNITS Menu Item

Specifies the four character label that is displayed to the right of the channel’s values.

NOTICE

This menu item doesn’t change the mathematical scaling of the channel’s values; that can be changed by altering the “CALIBRATION DATA -> FULL SCALE VALUE” menu item and then performing a re-calibration.

When a character position is flashing press the [UP] or [DOWN] button to change the character. Press [ENTER] to advance to the next character.

This menu item may be automatically updated by a transducer’s *Signature Module*.

DISPLAY. AVERAGE Menu Item

Controls the speed with which the channel’s display values will update. Display averaging does not affect the DAC Output or peak/valley detection, which will proceed at the speed selected by the “OPERATION -> FREQ. RESPONSE” menu item. The choices are:

- “ON” means that the display will update four times each second. The channel’s values will be averaged for 1/4 second, then displayed.
- “OFF” means that the channel’s display will update as quickly as possible.

10.5.3 AUX_n FUNCTION Menu Items

The AUX1 FUNCTION and AUX2 FUNCTION menu items determine what happens when the Auxiliary Function pins (labeled as “AUX1” and “AUX2”) on the Input Channel connector are activated. These pins are “activated” when they are connected to the (-)Signature (labeled as “-MEM”) pin. The choices are:

- “DISABLED” means that activating the pin does nothing.

- "TRACK HOLD" means that the tracking, peak and valley values will not be updated.
- "HIGH/LOW HOLD" means that the peak and valley values will not be updated.
- "HIGH/LOW CLEAR" means that the peak and valley values are reset.
- "TARE ON" activates the channel's Tare function (resets it to zero).
- "TARE OFF" deactivates the channel's Tare function.

As the Auxiliary Function pins are not isolated, it is recommended that a push-button switch or relay is used to connect these pins to the (-)Signature pin.

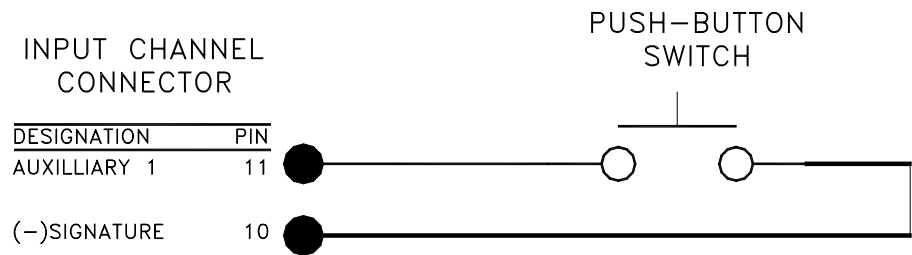

Figure 10-5: Auxilliary Input Example

NOTICE

A SensoCode program running on a Mathematics Virtual Channel may override the default behavior of the Auxilliary Function inputs. Consult the Customer Information Sheet included with your instrument for details.

**10.5.4 CALIBRATION
TYPE Menu Item**

This chooses the type of calibration technique to be used. There are three methods that can be used to calibrate the transducer to the Input Channel. Each has advantages and disadvantages as described in the table below.

Table 4-9: Comparison of Calibration Types

	Shunt Calibration	mV/V Calibration	2-, 3-, or 5- point Known Load Calibration
RECOMMENDED...			
...for most applications	no	yes	no
...when frequently swapping transducers	yes	yes	no
...when best possible accuracy required	no	no	yes
PROS and CONS			
Relative accuracy	good	better	best
Requires actual, calibrated loads to be applied	no	no	yes
Automatically calibrates with <i>Signature Calibration</i> transducers	yes	yes	no
Max. distance of transducer from instrument	15' [5m]	50' [15m]	300' [100m]
CALIBRATION TECHNIQUE			
Zero-scale point from...	applied load	applied load	applied load
Full-scale point from...	transducer output when shunt resistor applied	internal reference	applied load
Linearity correction from...	data stored in <i>Signature Module</i> (if available)	data stored in <i>Signature Module</i> (if available)	2-point: none 3- or 5-point: applied load

It is important to know your application in order to select the appropriate calibration type. mV/V (“millivolt-per-volt”) Calibration is recommended for most applications because it doesn’t require known loads and it allows easy swapping of transducers equipped with *Signature Calibration*. When the best possible accuracy is required, Known-Load Calibration is recommended.

The choices for this menu item are:

- “TYPE= SHUNT CAL” means Shunt Calibration. First, you are prompted to apply the load entered in the “ZERO SCALE VALUE” register. Next, the instrument inserts a known, precision resistor into the transducer circuit, which causes a predictable apparent signal. The instrument then takes a reading and adjusts itself using the

“SHUNT CAL VALUE” register.

- “TYPE= MV/V CAL” means Millivolt-per-Volt Calibration. First, you are prompted to apply the load entered in the “ZERO SCALE VALUE” register. Next, the instrument takes a reading from an accurate, internal mV/V reference. The instrument then uses the “FULL SCALE MV/V” and “FULL SCALE VALUE” values in mathematical calculations to scale its tracking values.
- “TYPE= 2 POINT CAL” means 2-Point Known Load Calibration. You are prompted to apply the loads to the transducer that were entered in the “KNOWN POINT 1/2” and “KNOWN POINT 2/2” registers. This technique assumes that the transducer is linear, so the usual loads used are zero scale and full scale.
- “TYPE= 3 POINT CAL” means 3-Point Known Load Calibration. You are prompted to apply the loads to the transducer that were entered in the “KNOWN POINT 1/3” and “KNOWN POINT 2/3” and “KNOWN POINT 3/3” registers. This technique can be used to compensate for the non-linearity in the transducer. The usual loads used are zero scale, half scale and full scale, but you are not restricted to these loads.
- “TYPE= 5 POINT CAL” means 5-Point Known Load Calibration. You are prompted to apply the loads to the transducer that were entered in the “KNOWN POINT 1/5”, “KNOWN POINT 2/5”, “KNOWN POINT 3/5”, “KNOWN POINT 4/5” and “KNOWN POINT 5/5” registers. This technique can be used to compensate for the non-linearity in the transducer. The usual loads used are zero scale, one-quarter scale, half scale, three-quarters scale and full scale, but you are not restricted to these loads.

The selection of the calibration type affects what menu items appear in the CALIBRATION DATA sub-menu.

10.5.5 CALIBRATION DATA Sub-Menu

This enters the values that will be used by the instrument when it calibrates itself to the transducer. The menu items that are displayed will change according to what the CALIBRATION TYPE is set for.

FULL SCALE MV/V Menu Item

The transducer output when its full-scale load is applied to it, in milliVolts-per-Volt. This menu item is used by the instrument to set the gain of its amplifier circuit, and (when the CALIBRATION TYPE is set to mV/V Calibration) to calibrate the instrument. This value is normally found on the transducer's Certificate of Calibration issued by its manufacturer.

This menu item may be automatically updated by a transducer's *Signature Module*. It is available for all calibration types.

FULL SCALE VALUE Menu Item

The transducer's full-scale output in engineering units.

This menu item may be automatically updated by a transducer's *Signature Module*. It is available only with the Shunt Calibration and mV/V Calibration types.

ZERO SCALE VALUE Menu Item

The transducer's zero-scale output in engineering units, which is usually zero.

This menu item may be automatically updated by a transducer's *Signature Module*. It is available only with the Shunt Calibration and mV/V Calibration types.

SHUNT CAL VALUE Menu Item

The shunt calibration value must be calculated by using information found on the transducer's Certificate of Calibration and the following formula:

$$\text{SHUNT CAL VALUE} = \frac{\text{Shunt-Calibration Output}}{\text{Full-Scale Output}} \times \text{Full-Scale Capacity}$$

The terms have the following meanings:

- *Shunt-Calibration Output*: The transducer's output under shunt calibration conditions in mV/V. Sometimes called "Shunt Cal. Factor".
- *Full-Scale Output*: The transducer's full-scale output in mV/V. Sometimes called "Calibration Factor".
- *Full-Scale Capacity*: The transducer's desired full-scale reading in engineering units (PSI, lbs, Kg, etc.). You may wish to convert the engineering units of this value. For example, if the transducer full scale is 3000PSIG and you wish the channel to read in bar, you must convert 3000PSIG into 206.84 bar.

This menu item may be automatically updated by a transducer's *Signature Module*.

See "Wiring" on page 52 for information on how, according to the wiring and transducer type, the instrument applies shunt calibration conditions to the transducer.

This menu item is only available with the Shunt Calibration type.

To verify proper transducer operation, you can apply the shunt resistor to the transducer while the instrument is in the RUN mode. Press and hold the [ENTER] button for three seconds; this will apply the shunt resistor and display the reading.

KNOWN POINT x/y Menu Items

This enters the engineering units for the known-load calibration points. These points must match the actual loads that you will apply to the instrument during calibration. The number of calibration points depends on the CALIBRATION TYPE.

When using the 2-Point Known Load Calibration type, the following menu items are available:

- "KNOWN POINT 1/2": point 1 of 2, usually 0% of the transducer's full-scale capacity.
- "KNOWN POINT 2/2": point 2 of 2, usually 100% of the transducer's full-scale capacity.

When using the 3-Point Known Load Calibration type, the following menu items are available:

- "KNOWN POINT 1/3": point 1 of 3, usually 0% of the transducer's full-scale capacity.
- "KNOWN POINT 2/3": point 2 of 3, usually 50% of the transducer's full-scale capacity.
- "KNOWN POINT 3/3": point 3 of 3, usually 100% of the transducer's full-scale capacity.

When using the 5-Point Known Load Calibration type, the following menu items are available:

- "KNOWN POINT 1/5": point 1 of 5, usually 0% of the transducer's full-scale capacity.
- "KNOWN POINT 2/5": point 2 of 5, usually 25% of the transducer's full-scale capacity.
- "KNOWN POINT 3/5": point 3 of 5, usually 50% of the transducer's full-scale capacity.
- "KNOWN POINT 4/5": point 4 of 5, usually 75% of the transducer's full-scale capacity.
- "KNOWN POINT 5/5": point 5 of 5, usually 100% of the transducer's full-scale capacity.

NOTICE

To insure both correct operation of the transducer and application of the load, the instrument expects the voltage applied at each known-load point to be increasing. For example, the load applied at Known-Load Point 2/2 must cause the transducer to produce a more positive voltage than at Known-Load Point 1/2.

These menu items are only available with the Known-Load Calibration types.

10.5.6 CALIBRATE Menu Item

This menu item performs a calibration according to what was entered in the CALIBRATION TYPE and CALIBRATION DATA menu items.

NOTICE

Before performing a calibration, the transducer must be connected to the instrument, the CALIBRATION TYPE must be selected (see "CALIBRATION TYPE Menu Item" on page 60), and the CALIBRATION DATA must be entered (see "CALIBRATION DATA Sub-Menu" on page 62).

NOTICE

For maximum accuracy, allow at least twenty minutes of warm-up with the excitation voltage applied to the transducer before calibration.

If the CALIBRATION TYPE is **Shunt Calibration...**

- The display will read `DOING SHUNT CAL`, and prompt you to `APPLY 00000 UNIT` (where 00000 and UNIT are previously entered as ZERO SCALE VALUE and DISPLAY. UNITS). When you have applied this load to the transducer, press [ENTER].
- The display will then read `WORKING` and calibration will take place. Upon completion, the display will indicate `DONE` and the instrument will return to the RUN mode.

If the CALIBRATION TYPE is **mV/V Calibration...**

- The display will read `DOING MV/V CAL`, and prompt you to `APPLY 00000 UNIT` (where 00000 and UNIT are previously entered as ZERO SCALE VALUE and DISPLAY. UNITS). When you have applied this load to the transducer, press [ENTER].
- The display will then read `WORKING` and calibration will take place. Upon completion, the display will indicate `DONE` and the instrument will return to the RUN mode.

If the CALIBRATION TYPE is **2-Point Known Load Calibration...**

- The display will read `DOING 2POINT CAL`, and prompt you to `APPLY 00000 UNIT` (where 00000 and UNIT are previously entered as KNOWN POINT 1/2 and DISPLAY. UNITS). When you have applied this load to the transducer, press [ENTER].
- The display will read `WORKING`, then `APPLY 01000 UNIT` (where 01000 and UNIT are previously entered as KNOWN POINT 2/2 and DISPLAY. UNITS). When you have applied this load to the transducer, press [ENTER].
- Upon completion, the display will indicate `DONE` and the instrument will return to the RUN mode.

If the CALIBRATION TYPE is **3-Point Known Load Calibration...**

- The display will read `DOING 3POINT CAL`, and prompt you to `APPLY 00000 UNIT` (where 00000 and UNIT are previously entered as KNOWN POINT 1/3 and DISPLAY. UNITS). When you have applied this load to the transducer, press [ENTER].
- The display will read `WORKING`, then `APPLY 00500 UNIT` (where 00500 and UNIT are previously entered as KNOWN POINT 2/3 and DISPLAY. UNITS). When you have applied this load to the transducer, press [ENTER].
- The display will read `WORKING`, then `APPLY 01000 UNIT` (where 01000 and UNIT are previously entered as KNOWN POINT 3/3 and DISPLAY. UNITS). When you have applied this load to the transducer, press [ENTER].
- Upon completion, the display will indicate `DONE` and the instrument will return to the RUN mode.

RUN mode.

If the CALIBRATION TYPE is **5-Point Known Load Calibration...**

- The display will read `DOING 5POINT CAL`, and prompt you to `APPLY 00000 UNIT` (where 00000 and UNIT are previously entered as `KNOWN POINT 1/5` and `DISPLAY. UNITS`). When you have applied this load to the transducer, press [ENTER].
- The display will read `WORKING`, then `APPLY 00250 UNIT` (where 00250 and UNIT are previously entered as `KNOWN POINT 2/5` and `DISPLAY. UNITS`). When you have applied this load to the transducer, press [ENTER].
- The display will read `WORKING`, then `APPLY 00500 UNIT` (where 00500 and UNIT are previously entered as `KNOWN POINT 3/5` and `DISPLAY. UNITS`). When you have applied this load to the transducer, press [ENTER].
- The display will read `WORKING`, then `APPLY 00750 UNIT` (where 00750 and UNIT are previously entered as `KNOWN POINT 4/5` and `DISPLAY. UNITS`). When you have applied this load to the transducer, press [ENTER].
- The display will read `WORKING`, then `APPLY 01000 UNIT` (where 01000 and UNIT are previously entered as `KNOWN POINT 5/5` and `DISPLAY. UNITS`). When you have applied this load to the transducer, press [ENTER].
- The display will now read `RETURN PNTS. =NO`. If you press [ENTER], the display will indicate `DONE` and the instrument will return to the RUN mode. If you use the [UP] button and [ENTER] to select `RETURN POINTS=YES`, you may now apply the same loads again but in reverse order. This will allow the instrument to measure and partially eliminate any hysteresis that may be present in the transducer. After the loads have been applied again, the display will indicate `DONE` and the instrument will return to the RUN mode.

10.5.7 DAC SETUP Sub-Menu

This sub-menu contains four items that control the Digital-to-Analog Converter (DAC) Output of the Input Channel.

The DAC Output is only available if the instrument was purchased with Option 58i.

DAC. CHANNEL Menu Item

This chooses which channel will drive the DAC Output. Normally, the DAC Output is driven by the Input Channel (Channel 01), but that need not be the case. For example, a Mathematics Virtual channel installed as Channel 02 could drive the Input Channel's DAC Output.

DAC. SOURCE Menu Item

This designates the data source of the channel monitored by the DAC Output.

The options for this menu item are:

- "TRACK" means the live tracking value of the channel.
- "PEAK" means the highest value of the channel since the peak/valley detector was last cleared.
- "VALLEY" means the lowest value of the channel since the peak/valley detector was last cleared.

DAC. ZERO-SCALE Menu Item

This specifies what value, in engineering units, corresponds to zero output on the DAC Output.

"Zero output" might be 0 Volts, 2.5 Volts or 5 Volts depending on how the DAC Output is configured. See "Digital-to-Analog Converter (DAC) Output Configuration" on page 69" for details.

If the UPDATE DAC SETUP menu item is set to "ON" and the DAC. CHANNEL menu item is set to this channel, this menu item may be automatically updated by a transducer's *Signature Module*. If the UPDATE DAC SETUP menu item is "OFF", a transducer's *Signature Module* will not change this menu item.

DAC. FULL-SCALE Menu Item

Specifies what value, in engineering units, corresponds to full output on the DAC Output.

"Full output" might be 5 Volts or 10 Volts depending on how the DAC Output is configured. See "Digital-to-Analog Converter (DAC) Output Configuration" on page 69" for details.

If the UPDATE DAC SETUP menu item is set to "ON" and the DAC. CHANNEL menu item is set to this channel, this menu item may be automatically updated by a transducer's *Signature Module*. If the UPDATE DAC SETUP menu item is "OFF", a transducer's *Signature Module* will not change this menu item.

10.5.8 SIGNATURE MODULE Sub-Menu

UPDATE SIG. MOD? Menu Item

Updates the information stored in the transducer's *Signature Module* with any new settings that is entered into the instrument with the SETUP menus. The settings that will be updated are:

- EXCITATION
- FULL SCALE MV/V
- FULL SCALE VALUE
- SHUNT CAL VALUE
- DISPLAY. UNITS

Note that changes made to the instruments display setup (such as decimal point and count-by settings) are not updated into the *Signature Module*.

Updating enters these new settings from the instrument into the *Signature Module*. If you do not update the *Signature Module*, connect a different transducer to the instrument and then re-connect the original transducer again, the instrument will revert to the settings that are stored inside the *Signature Module*.

The options for this menu item are:

- "NO" will not update the *Signature Module*.
- "YES" will display WORKING, update the *Signature Module*, then display DONE.

DEFAULT SIG. MOD? Menu Item

This menu item will overwrite any user settings in the *Signature Module* with the original default settings. The *Signature Module* always maintains a copy of the original default settings that were created at the factory.

The options for this menu item are:

- "NO" will not restore original default settings.
- "YES" will display WORKING, update the *Signature Module*, with the original factory settings, then display DONE.

UPDATE DAC SETUP Menu Item

This menu item determines whether or not the DAC. FULL SCALE and DAC. ZERO SCALE settings are overwritten with information from a *Signature Module* when a new transducer is detected by the instrument.

The options for this menu item are:

- "YES" will allow a newly detected *Signature Module* to update the DAC Output settings.
- "NO" will not allow automatic updating of the DAC Output settings.

10.5.9 DIAGNOSTICS

Sub-Menu

DAC FULL SCALE Menu Item	When this menu item is selected, the DAC Output is forced to its full-scale output, then DAC UPDATED is displayed. This is useful when calibrating or trimming the readout connected to the DAC Output.
DAC ZERO SCALE Menu Item	When this menu item is selected, the DAC Output is forced to its zero-scale output, then DAC UPDATED is displayed. This is useful when calibrating or trimming the readout connected to the DAC Output.
VERSION INFO Menu Item	This menu item displays the part number and revision level of the firmware used by the instrument's microprocessor.
DISPLAY ADC Menu Item	<p>The options for this menu item are:</p> <ul style="list-style-type: none">• "OFF" will allow the [VALUE] button to cycle through "TK" (tracking value), "HI" (peak value) and "LO" (valley value). This is the recommended option.• "ON" will allow the "AD" (percentage of the Analog-to-Digital converter's full-scale digitizing capability) display source to be available along with "TK" (tracking value), "HI" (peak value) and "LO" (valley value) when the [VALUE] button is pressed on the front panel. <p>The Analog-to-Digital converter counts are displayed as a percentage from -100.00% to 100.00%.</p> <p>This can be used to verify that the transducer's output does not exceed the input range of the instrument. If the Analog-to-Digital converter readings display more than +/-10% when there is no load on the transducer, the transducer has a high zero offset.</p>
LINEARIZATION Menu Item	<p>The options for this menu item are:</p> <ul style="list-style-type: none">• "ON" will allow linearization data obtained from either the Signature Module or a 3-Point or 5-Point Known Load Calibration to affect a channel's scaled values. This is the recommended option.• "OFF" will not allow linearization data to effect the channel's scaled values. This is useful when diagnosing problems in a calibration procedure.
DISABLE CHANNEL Menu Item	<p>The options for this menu item are:</p> <ul style="list-style-type: none">• "ON" will bypass the INITIALIZE and RUN modes of the channel. The track, peak and valley values of the channel are forced to 0.• "OFF" will allow normal operation of the channel.

10.6 Digital-to-Analog Converter (DAC) Output Configuration

10.6.1 Channel Menu Items The DAC Output can be driven by any channel's track, peak or valley value.

See the "Channel Menu" section earlier in this chapter for a complete listing of SETUP menu items available on the DAC. SETUP sub-menu.

10.6.2 Output Selection

Jumpers located on the Main Circuit Board determine what outputs are generated when the value selected to drive the DAC Output (from the DAC. CHANNEL and DAC. SOURCE menu items) equals the DAC. FULL SCALE and DAC. ZERO SCALE settings.

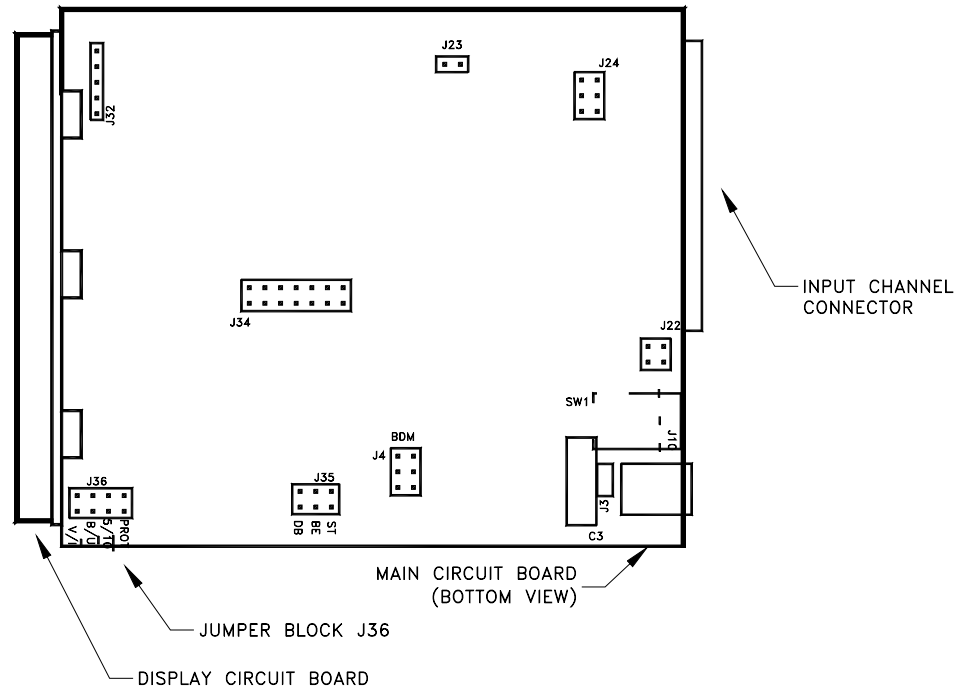

Figure 10-6: Digital-to-Analog Output Jumper Locations

	DAC. ZERO SCALE Output	DAC. FULL SCALE Output	Jumper Block J36	
			5/10 jumper	B/U jumper
0-5V	2.5 Volts	5 Volts	closed	open
±5V	0 Volts	5 Volts	closed	closed
0-10V	5 Volts	10 Volts	open	open
±10V	0 Volts	10 Volts	open	closed

10.7 Troubleshooting

10.7.1 Error Messages

See “Error Messages” on page 127 for information relating to error messages.

10.7.2 Common Problems and Solutions

Erratic Display

Check electrical connections for continuity and the transducer's wiring code from its Certificate of Calibration.

Make sure that the load on the transducer is constant.

Check millivolt input to the (+)Signal (“+SIG”) and (-)Signal (“-SIG”) pins with a voltmeter.

+OVLD or -OVLD on Display

Indicates that the voltage across the (+)Signal (“+SIG”) and (-)Signal (“-SIG”) pins is overranging or underranging the amplifier circuit. Make certain all wires are connected properly.

If you remove all load from the transducer and you still see this message, the (+)Excitation (“+EXC”) or (-)Excitation (“-EXC”) pins may be shorted to the (+)Signal (“+SIG”) or (-)Signal (“-SIG”) pins.

If you remove all load from the transducer and you get a numeric reading, the transducer may have a high zero offset. Use the channel's SETUP menu and set `DIAGNOSTICS -> DISPLAY ADC` to “ON”; in the RUN mode this will allow the [VALUE] button to display raw A/D readings as a percentage of its full-scale. If the raw A/D readings display more than +/-10% when there is no load on the transducer, the transducer has a high zero offset.

DAC Output Incorrect

The DAC Output is only available on instruments ordered with Option 58i.

Use the `DIAGNOSTICS -> DAC FULL SCALE` and `DIAGNOSTICS -> DAC ZERO SCALE` menu items to force the DAC Output to a known output. Then, adjust your readout device, panel meter, PLC or data acquisition system to match.

Check the output selection jumpers; see “Output Selection” on page 69.

“APPLY 0000” on Power-up

The channel has detected that the transducer connected to the instrument is different than the one the channel was last calibrated with. Because the `CALIBRATION TYPE` is set to either Shunt Calibration or mV/V Calibration, the instrument is prompting you to apply zero load in order to auto-calibrate to this new transducer.

Do one of the following, depending on the situation:

- Re-connect the original transducer to the channel and re-start the instrument.
- Press [ENTER] to re-calibrate the channel to this new transducer using Shunt or mV/V Calibration and accept the presently applied load as “0”. (In situations where one can't apply “0” load to an absolute pressure transducer or a load cell with a pre-load, you can change the `CALIBRATION DATA -> ZERO-SCALE VALUE` menu item from “0” to a load that can be applied. For example, 14.7 PSIA or the known pre-load on the load cell.
- Use the `CALIBRATE` menu item to perform a Known-Load Calibration with this new transducer.

Auxiliary Function Pins Not Operating

Make sure that the `AUX1 FUNCTION` or `AUX2 FUNCTION SETUP` menu items are set correctly; if they are set to `DISABLED` then they will not operate.

The Auxiliary Function (“AUX1” and “AUX2”) pins must be connected to the -MEM pin to activate them.

Sensitivity to EMI/RFI

To obtain maximum immunity to electromagnetic or radio frequency interference, make certain that the shields of the transducer cables are connected to the “cable shield connection screw” on the rear panel of the instrument. See “Unamplified Transducer Connection to Strain-Gage Input Channel” on page 53, “External Arrangement of Model SC500” on page 27.

Shunt Calibration Feature not Operating

To activate the channel’s shunt calibration function while the instrument is in RUN Mode, see “Shunt Calibration Check” on page 21. This serves as a quick check of the shunt cal feature.

Problems with shunt calibration are most likely caused by incorrect wiring, incorrect shunt cal resistor or using an incorrect instrument Shunt Cal Application configuration.

- Verify that the shunt calibration resistor installed on the Main Circuit Board is the correct value per the transducer’s Calibration Record.
- Most unamplified strain-gage transducers do not include a “buffered shunt cal” feature. Verify that jumper settings are correct according to Table 4-8, “Shunt Cal Application Configuration,” on page 54.

Chapter 11

AC/AC-LVDT Input Channel

11.1 Features

The AC/AC-LVDT Input channel provides an AC excitation voltage to and accepts AC signals from LVDT (Linear Variable Differential Transformer) transducers. These signals are digitized, converted into engineering units, and placed into the track, peak and valley data values of the channel. Setup and calibration of the channel are made manually through the SETUP mode.

The analog-to-digital converter features adjustable digital, low-pass filtering, 12- to 18-bit resolution (depending on the filter setting) and has several different input ranges. These many input ranges allow $\pm 25,000$ count resolution (at the slowest filter setting) for a wide variety of LVDT outputs.

The AC/AC-LVDT Input channel is calibrated to the transducer by using known-displacement calibration.

Two rear panel control inputs can be field-configured for such functions as remote tare, disabling peak/valley detection and clearing the peak/valley values. A standard voltage or optional current digital-to-analog output is also provided.

NOTICE

To use a DC/DC LVDT with a the instrument, use a High-Level Input channel instead of an AC/AC-LVDT Input channel.

11.2 Wiring

Connect your transducer to an AC/AC-LVDT Input channel by wiring it to the Input Channel connector (the top connector on the instrument's rear panel). The Customer Information Sheet that shipped with the instrument describes which cards are installed in each channel. The pin-out for this connector is shown on the following table.

Table 5-10: AC/AC-LVDT Input Channel Pin Connections

Pin	Label	Function	Reference Pin	Availability
1 (left)	+EXC	(+)Excitation	10	standard
2	N/C	No connection		
3	N/C	No connection		
4	-EXC	(-)Excitation	10	standard
5	+SIG	(+)Signal	10	standard
6	-SIG	(-)Signal	10	standard
7	+OUT	DAC Output	8	Option 58i
8	-OUT	DAC Return	-	Option 58i
9	N/C	No connection		
10	DGND	Digital Ground	-	standard
11	AUX1	Auxiliary Function 1 (connect to pin 10 to activate)	10	standard
12 (right)	AUX2	Auxiliary Function 2 (connect to pin 10 to activate)	10	standard

The DAC Output and DAC Return pins are electrically isolated from all other pins on the instrument.

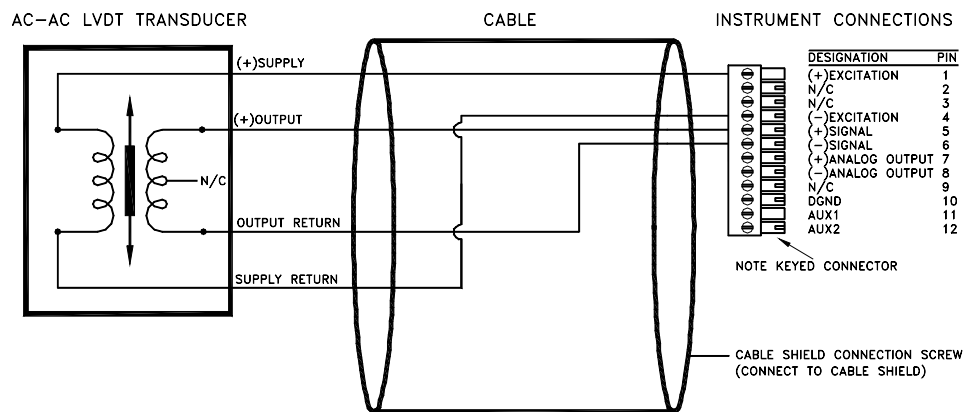

Figure 11-1: Connection of Four- or Five-wire AC/AC-LVDT

11.3 Calibration Procedure

If you are not familiar with operating the instrument in the SETUP menu mode, see “SETUP Menu mode” on page 23. A listing of all menu items is given in “Setup Menu Reference” on page 133.

Step 1: Wire the transducer to the channel’s connector.

See “Wiring” on page 74 for details.

Step 2: Enter the CALIBRATION TYPE.

You must have the capability to apply either two, three, or five known displacements to the transducer. The CALIBRATION TYPE menu item allows you to specify how many known displacements will be applied during calibration.

Step 3: Enter the CALIBRATION DATA.

Consult the Certificate of Calibration for the transducer when entering information in the CALIBRATION DATA sub-menu.

Step 4: Determine the LVDT’s electrical null point, then physically mount it.

The electrical null is the armature position that produces the least electrical output. Once this point has been determined, the transducer is physically clamped into position. See “Electrical Null and Transducer Mounting” on page 87.

Step 5: Perform the calibration.

Using the CALIBRATE menu item starts the calibration process. You will be prompted to apply displacements to the transducer as required.

11.4 Specifications

TRANSDUCER INPUT

Transducer type	full-bridge, AC/AC-LVDT
Excitation Voltage	3 VRMS @ 5kHz, short circuit protected
Transducer full-scale output	.1 to 15 VRMS @ 3 VRMS excitation
Amplifier Gain Selection	automatic
Calibration Type	2-, 3- or 5- point known displacement
A/D Converter	24-bit Sigma-Delta
Low-pass filter	digital, 24-tap FIR
Resolution	see page 77
Frequency Response	see page 77

AUXILLIARY INPUTS

Quantity	2
Type	momentary contact closure
Response Time	< 5ms
Field-Selectable Functions	tare on, tare off, peak/valley clear, peak/valley hold, track hold

DIGITAL-TO-ANALOG OUTPUT

Availability	with Option 58i
Output voltage range	5, ± 5 , 10 or ± 10 VDC (field selectable)
Source	any channel's track, peak or valley value
Isolation	500V
Resolution	14 bits
Frequency Response	same as input if driven by the same channel's tracking data

11.5 Channel Menu

Each AC/AC-LVDT Input channel is configured and calibrated via its channel menu. Detailed instructions on operating the instrument in the SETUP Menu mode can be found in “SETUP Menu mode” on page 23. A diagram of all menus is located in “Setup Menu Reference” on page 133.

11.5.1 OPERATION Sub-Menu

This menu controls the operation of this channel when the instrument is in the RUN mode.

AUTO-ZERO Menu Item

This enables or disables the channel's automatic zeroing function. When enabled, the channel will reset its tracking value to zero when the tracking value is less than 10 display counts for a period of 10 seconds. This removes the effect of slight temperature shifts in the transducer's output.

NOTICE

To compensate for the transducer's initial warm-up shift, the auto-zero function operates every 2 seconds during the first 60 seconds of RUN mode operation.

The two options for this menu item are “ON” and “OFF”.

FREQ. RESPONSE Menu Item

This sets the frequency response, step response, and resolution of the channel according to the table below. The tracking value, peak/valley detector values and DAC Output are all affected. The default value of 016. HERTZ is suitable for most applications.

Frequency Response	Step Response (ms) (typical)	Resolution (counts) (not including minimum 10% overrange/underrange capability)
002. HERTZ/FAST	40	±25000
002. HERTZ	440	±25000
008. HERTZ	110	±15000
016. HERTZ	55	±10000
032. HERTZ	28	±10000
050. HERTZ	16	±5000
100. HERTZ	8	±5000
250. HERTZ	3	±2000

NOTICE

Your particular LVDT may have a lower frequency response than the AC-AC LVDT Input channel.

POWER-ON SOURCE Menu Item

This menu selects which value is displayed by the channel when first entering the RUN mode.

The choices are:

- “TRACK” means the live tracking value of the channel.
- “PEAK” means the highest value of the channel.
- “VALLEY” means the lowest value of the channel.

11.5.2 DISPLAY SETUP Sub-Menu

This menu controls how data values are displayed by the channel and transmitted via serial communications.

DISPLAY. DIGITS Menu Item

Selects the number of digits displayed by the channel. The choices are:

- "5 DIGIT-BIPOLAR" displays both positive and negative numbers with five full digits (± 99999).
- "6 DIGIT-UNIPOAR" displays positive numbers with six full digits (999999) and negative numbers with five full digits (-99999).
- "7 DIGIT UNIPOLAR" displays positive number with seven full digits (9999999) and negative numbers with six digits (-999999).

DISPLAY. DECPY Menu Item

Selects the decimal point location on the channel's display and serial communications output. Use the [UP] and [DOWN] buttons to move the decimal point to the right and left.

DISPLAY. COUNT-BY Menu Item

Determines by what value the display increments or decrements. This will make the display less sensitive to a noisy signal. The choices are:

- "00001"
- "00002"
- "00005"
- "00010"
- "00020"
- "00050"
- "00100"
- "00200"

DISPLAY. UNITS Menu Item

Specifies the four character label that is displayed to the right of the channel's values.

NOTICE

This menu item doesn't change the mathematical scaling of the channel's values; that can be changed by altering the "CALIBRATION DATA -> KNOWN POINT X/Y" menu items and then performing a re-calibration.

When a character position is flashing press the [UP] or [DOWN] button to change the character. Press [ENTER] to advance to the next character.

DISPLAY. AVERAGE Menu Item

Controls the speed with which the channel's display values will update. Display averaging does not affect the DAC Output or peak/valley detection, which will proceed at the speed selected by the "OPERATION -> FREQ. RESPONSE" menu item. The choices are:

- "ON" means that the display will update four times each second. The channel's values will be averaged for 1/4 second, then displayed.
- "OFF" means that the channel's display will update as quickly as possible.

11.5.3 AUX_n FUNCTION Menu Items

The AUX1 FUNCTION and AUX2 FUNCTION menu items determine what happens when the Auxiliary Function pins (labeled as "AUX1" and "AUX2") on the Input Channel connector are activated. These pins are "activated" when they are connected to the DGND pin. The choices are:

- "DISABLED" means that activating the pin does nothing.
- "TRACK HOLD" means that the tracking, peak and valley values will not be updated.
- "HIGH/LOW HOLD" means that the peak and valley values will not be updated.
- "HIGH/LOW CLEAR" means that the peak and valley values are reset.

- “TARE ON” activates the channel’s Tare function (resets it to zero).
- “TARE OFF” deactivates the channel’s Tare function.

As the Auxiliary Function pins are not isolated, it is recommended that a push-button switch or relay is used to connect these pins to the DGND pin.

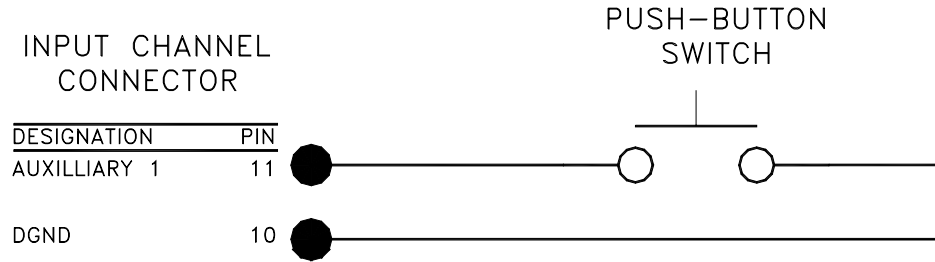

Figure 11-2: Auxilliary Input Example

NOTICE

A SensoCode program running on a Mathematics Virtual Channel may override the default behavior of the Auxilliary Function inputs. Consult the Customer Information Sheet included with your instrument for details.

11.5.4 CALIBRATION TYPE Menu Item

The choices for this menu item are:

- "TYPE= 2 POINT CAL" means 2-Point Known Displacement Calibration. You are prompted to apply the displacements to the transducer that were entered in the "KNOWN POINT 1/2" and "KNOWN POINT 2/2" registers. This technique assumes that the transducer is linear throughout the entire stroke, so the usual displacements used are zero scale and full scale.
- "TYPE= 3 POINT CAL" means 3-Point Known Displacement Calibration. You are prompted to apply the displacements to the transducer that were entered in the "KNOWN POINT 1/3" and "KNOWN POINT 2/3" and "KNOWN POINT 3/3" registers. This technique can be used to compensate for the different sensitivities that an LVDT may have on each side of its electrical null. The usual displacements used are zero scale, half scale and full scale, but you are not restricted to these displacements.
- "TYPE= 5 POINT CAL" means 5-Point Known Displacement Calibration. You are prompted to apply the displacements to the transducer that were entered in the "KNOWN POINT 1/5", "KNOWN POINT 2/5", "KNOWN POINT 3/5", "KNOWN POINT 4/5" and "KNOWN POINT 5/5" registers. This technique can be used to compensate for the non-linearity in the transducer as well as the different sensitivities on each side of its electrical null. The usual displacements used are zero scale, one-quarter scale, half scale, three-quarters scale and full scale, but you are not restricted to these displacements.

The selection of the calibration type affects what menu items appear in the CALIBRATION DATA sub-menu.

11.5.5 CALIBRATION DATA Sub-Menu

This sub-menu enters the values that will be used by the instrument when it calibrates itself to the transducer. The menu items that are displayed will change according to what the CALIBRATION TYPE is set for.

FULL SCALE VRMS Menu Item

The transducer output when its full-scale displacement is applied to it, in Volts RMS (root-mean-squared) assuming 3 VRMS excitation. This menu item is used by the instrument to set gain of its amplifier circuit. This value is normally found on the transducer's Certificate of Calibration issued by its manufacturer.

KNOWN POINT x/y Menu Items

This enters the engineering units for the known-displacement calibration points. These points must match the actual displacements that you will apply to the transducer during calibration. The number of calibration points depends on the CALIBRATION TYPE.

When using the 2-Point Known Displacement Calibration type, the following menu items are available:

- "KNOWN POINT 1/2": point 1 of 2, usually 0% of the transducer's full-scale capacity.
- "KNOWN POINT 2/2": point 2 of 2, usually 100% of the transducer's full-scale capacity.

When using the 3-Point Known Displacement Calibration type, the following menu items are available:

- "KNOWN POINT 1/3": point 1 of 3, usually 0% of the transducer's full-scale capacity.
- "KNOWN POINT 2/3": point 2 of 3, usually 50% of the transducer's full-scale capacity.
- "KNOWN POINT 3/3": point 3 of 3, usually 100% of the transducer's full-scale capacity.

When using the 5-Point Known Displacement Calibration type, the following menu items are available:

- "KNOWN POINT 1/5": point 1 of 5, usually 0% of the transducer's full-scale capacity.
- "KNOWN POINT 2/5": point 2 of 5, usually 25% of the transducer's full-scale capacity.
- "KNOWN POINT 3/5": point 3 of 5, usually 50% of the transducer's full-scale capacity.
- "KNOWN POINT 4/5": point 4 of 5, usually 75% of the transducer's full-scale capacity.
- "KNOWN POINT 5/5": point 5 of 5, usually 100% of the transducer's full-scale capacity.

NOTICE

To insure both correct operation of the transducer and application of the displacement, the instrument expects the voltage applied at each known-displacement point to be increasing. For example, the displacement applied at Known-Displacement Point 2/2 must cause the transducer to produce a more positive voltage than at Known-Displacement Point 1/2. You may need to swap the (+)Signal and (-)Signal wires on the 12-pin channel connector to accomplish this.

11.5.6 CALIBRATE Menu Item

This menu item performs a calibration according to what was entered in the CALIBRATION TYPE and CALIBRATION DATA menu items.

NOTICE

Before performing a calibration, the transducer must be connected to the instrument, the CALIBRATION TYPE must be selected (see "CALIBRATION TYPE Menu Item" on page 80) and the CALIBRATION DATA must be entered (see "CALIBRATION DATA Sub-Menu" on page 81).

NOTICE

For maximum accuracy, allow at least twenty minutes of warm-up with the excitation voltage applied to the transducer before calibration.

If the CALIBRATION TYPE is **2-Point Known Displacement Calibration...**

- The display will read `DOING 2POINT CAL`, and prompt you to `APPLY 00000 UNIT` (where 00000 and UNIT are previously entered as `KNOWN POINT 1/2` and `DISPLAY. UNITS`). When you have applied this displacement to the transducer, press `[ENTER]`.
- The display will read `WORKING`, then `APPLY 01000 UNIT` (where 01000 and UNIT are previously entered as `KNOWN POINT 2/2` and `DISPLAY. UNITS`). When you have applied this displacement to the transducer, press `[ENTER]`.
- Upon completion, the display will indicate `DONE` and the instrument will return to the RUN mode.

If the CALIBRATION TYPE is **3-Point Known Displacement Calibration...**

- The display will read `DOING 3POINT CAL`, and prompt you to `APPLY 00000 UNIT` (where 00000 and UNIT are previously entered as `KNOWN POINT 1/3` and `DISPLAY. UNITS`). When you have applied this displacement to the transducer, press `[ENTER]`.
- The display will read `WORKING`, then `APPLY 00500 UNIT` (where 00500 and UNIT are previously entered as `KNOWN POINT 2/3` and `DISPLAY. UNITS`). When you have applied this displacement to the transducer, press `[ENTER]`.
- The display will read `WORKING`, then `APPLY 01000 UNIT` (where 01000 and UNIT are previously entered as `KNOWN POINT 2/3` and `DISPLAY. UNITS`). When you have applied this displacement to the transducer, press `[ENTER]`.
- Upon completion, the display will indicate `DONE` and the instrument will return to the RUN mode.

If the CALIBRATION TYPE is **5-Point Known Displacement Calibration...**

- The display will read `DOING 5POINT CAL`, and prompt you to `APPLY 00000 UNIT` (where 00000 and UNIT are previously entered as `KNOWN POINT 1/5` and `DISPLAY. UNITS`). When you have applied this displacement to the transducer, press `[ENTER]`.
- The display will read `WORKING`, then `APPLY 00250 UNIT` (where 00250 and UNIT are previously entered as `KNOWN POINT 2/5` and `DISPLAY. UNITS`). When you have applied this displacement to the transducer, press `[ENTER]`.
- The display will read `WORKING`, then `APPLY 00500 UNIT` (where 00500 and UNIT are

previously entered as KNOWN POINT 3/5 and DISPLAY. UNITS). When you have applied this displacement to the transducer, press [ENTER].

- The display will read WORKING, then APPLY 00750 UNIT (where 00750 and UNIT are previously entered as KNOWN POINT 4/5 and DISPLAY. UNITS). When you have applied this displacement to the transducer, press [ENTER].
- The display will read WORKING, then APPLY 01000 UNIT (where 01000 and UNIT are previously entered as KNOWN POINT 5/5 and DISPLAY. UNITS). When you have applied this displacement to the transducer, press [ENTER].
- Upon completion, the display will indicate DONE and the instrument will return to the RUN mode.

11.5.7 DAC SETUP Sub-Menu

This sub-menu contains four items that control the Digital-to-Analog (DAC) Output of the channel.

The DAC Output is only available if the instrument was purchased with Option 58i.

DAC. CHANNEL Menu Item

This chooses which channel will drive the DAC Output. Normally, the DAC Output is driven by the Input Channel (Channel 01), but that need not be the case. For example, a Mathematics Virtual channel installed as Channel 02 could drive the Input Channel's DAC Output.

DAC. SOURCE Menu Item

This designates the data source of the channel monitored by the DAC Output.

The options for this menu item are:

- "TRACK" means the live tracking value of the channel.
- "PEAK" means the highest value of the channel since the peak/valley detector was last cleared.
- "VALLEY" means the lowest value of the channel since the peak/valley detector was last cleared.

DAC. ZERO-SCALE Menu Item

This specifies what value, in engineering units, corresponds to zero output on the DAC Output.

"Zero output" might be 0 Volts, 2.5 Volts or 5 Volts depending how the DAC Output is configured. See "Digital-to-Analog Converter (DAC) Output Configuration" on page 88 for details.

DAC. FULL-SCALE Menu Item

This specifies what value, in engineering units, corresponds to full output on the DAC Output.

"Full output" might be 5 Volts or 10 Volts depending on how the DAC Output is configured. See "Digital-to-Analog Converter (DAC) Output Configuration" on page 88 for details.

11.5.8 DIAGNOSTICS

Sub-Menu

DAC FULL SCALE Menu Item	When this menu item is selected, the DAC Output is forced to its full-scale output, then <code>DAC UPDATED</code> is displayed. This is useful when calibrating or trimming the readout connected to the DAC Output.
DAC ZERO SCALE Menu Item	When this menu item is selected, the DAC Output is forced to its zero-scale output, then <code>DAC UPDATED</code> is displayed. This is useful when calibrating or trimming the readout connected to the DAC Output.
VERSION INFO Menu Item	This menu item displays the part number and revision level of the firmware used by this channels microprocessor.
DISPLAY ADC Menu Item	<p>The options for this menu item are:</p> <ul style="list-style-type: none">• “OFF” will allow the [VALUE] button to cycle through “TK” (tracking value), “HI” (peak value) and “LO” (valley value). This is the recommended option.• “ON” will allow the “AD” (percentage of the Analog-to-Digital converter’s full-scale digitizing capability) display source to be available along with “TK” (tracking value), “HI” (peak value) and “LO” (valley value) when the [VALUE] button is pressed on the front panel. <p>The Analog-to-Digital converter counts are displayed as a percentage from -100.00% to 100.00%.</p> <p>This can be used to establish the transducer’s electrical null prior to mounting. See “Electrical Null and Transducer Mounting” on page 87 for this procedure.</p>
LINEARIZATION Menu Item	<p>The options for this menu item are:</p> <ul style="list-style-type: none">• “ON” will allow linearization data obtained from a 3-Point or 5-Point Known Displacement Calibration to affect a channel’s scaled values. This is the recommended option.• “OFF” will not allow linearization data to effect the channel’s scaled values.
DISABLE CHANNEL Menu Item	<p>The options for this menu item are:</p> <ul style="list-style-type: none">• “ON” will bypass the INITIALIZE and RUN modes of the channel. The track, peak and valley values of the channel are forced to 0.• “OFF” will allow normal operation of the channel.

11.6 Electrical Null and Transducer Mounting

11.6.1 Overview

The mechanical travel of an LVDT transducer is not the same as its usable measuring range. All LVDTs exhibit some non-linearity near the ends of its armature's mechanical travel. To insure that the LVDT will be used in its linear measuring range, its electrical null point must be determined. This electrical null point is the armature position which produces the minimal electrical signal output. After electrical null has been established, the LVDT is clamped down into final position in its mounting fixture.

As long as the LVDT remains clamped in this position, you do not need to re-establish the electrical null prior to every calibration.

11.6.2 Procedure

Step 1: Use the channel's SETUP menu and set `DIAGNOSTICS -> DISPLAY ADC` to "ON". Exit the SETUP menu and re-start the instrument.

Step 2: Display the channel to which the LVDT is connected. Press and release the [VALUE] button until the "AD" display source is shown. This is the raw analog-to-digital converter readings displayed as a percentage of its full-scale (-100% to +100%).

Step 3: Move the LVDT's armature to the position which displays the lowest value of raw analog-to-digital converter readings (i.e. a number close to 00.000%). This is the LVDT's electrical null.

Step 4: Firmly clamp down the LVDT's body.

Step 5: Move the LVDT's armature to roughly the position you wish to define as "positive full scale". If the displayed analog-to-digital converter reading is a negative value, you must swap the wires connected to the (+)Signal and (-)Signal pins (labeled as "+SIG" and "-SIG") on the channel's 12-pin connector to make the reading positive.

11.7 Digital-to-Analog Converter (DAC) Output Configuration

11.7.1 Identifying the Output Type

An AC/AC-LVDT Input channel is available with one of two types of digital-to-analog (DAC) outputs: voltage or current. You can determine which type of output a channel has by one of three ways:

- Consulting the instrument's Customer Information Sheet
- Examining the SYSTEM MENU -> CONFIGURATION -> CHANNEL nn TYPE menu item where nn is the number of the channel. If the channel's type is AC-AC LVDT V, it has a voltage output. If the channel's type is AC-AC LVDT I, it has a current output.
- Examining the channel's circuit board as shown in the figure below.

11.7.2 Channel Menu Items

The DAC Output can be driven by any channel's track, peak or valley value.

See the "Channel Menu" section earlier in this chapter for a complete listing of SETUP menu items available on the DAC. SETUP sub-menu.

11.7.3 Output Selection

Jumpers located on the Main Circuit Board determine what outputs are generated when the value selected to drive the DAC Output (from the DAC. CHANNEL and DAC. SOURCE menu items) equals the DAC. FULL SCALE and DAC. ZERO SCALE settings.

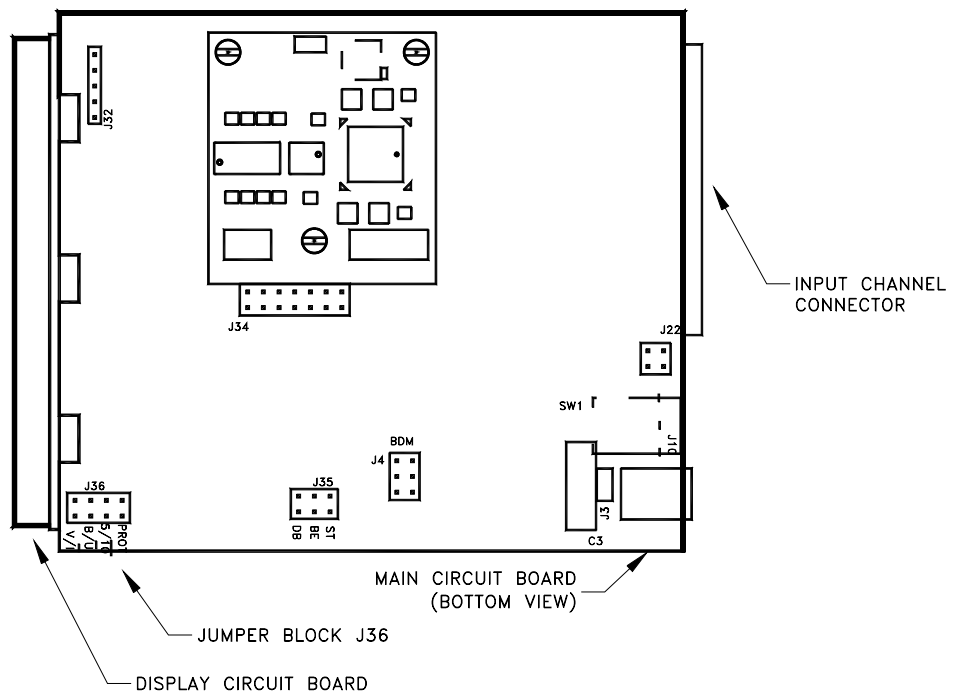

Figure 11-3: Digital-to-Analog Output Jumper Locations

	DAC. ZERO SCALE Output	DAC. FULL SCALE Output	Jumper Block J36	
			5/10 jumper	B/ \bar{U} jumper
0-5V	2.5 Volts	5 Volts	closed	open
$\pm 5V$	0 Volts	5 Volts	closed	closed
0-10V	5 Volts	10 Volts	open	open
$\pm 10V$	0 Volts	10 Volts	open	closed

11.8 Troubleshooting

11.8.1 Error Messages See “Error Messages” on page 127 for information relating to error messages.

11.8.2 Common Problems and Solutions

Erratic Display	<p>Check electrical connections for continuity and the transducer’s wiring code from its Certificate of Calibration.</p> <p>Make sure that the displacement on the transducer is constant.</p> <p>Check the input to the (+)Signal (“+SIG”) and (-)Signal (“-SIG”) pins with an RMS voltmeter in its “AC Voltage” mode. Using a voltmeter in its DC Voltage mode will always display 0.</p>
+OVL or -OVL on Display	<p>Indicates that the voltage across the (+)Signal (“+SIG”) and (-)Signal (“-SIG”) pins is overranging or underranging the amplifier circuit. Make certain all wires are connected properly, the “CALIBRATION DATA -> FULL SCALE VRMS” menu item is set correctly, and that a calibration has been performed per “Calibration Procedure” on page 75.</p> <p>If you move the armature back to its electrical null point and you still see this message, the (+)Excitation (“+EXC”) or (-)Excitation (“-EXC”) pins may be shorted to the (+)Signal (“+SIG”) or (-)Signal (“-SIG”) pins.</p>
DAC Output Incorrect	<p>The DAC Output is only available on instruments that were ordered with Option 58i.</p> <p>Use the <code>DIAGNOSTICS -> DAC FULL SCALE</code> and <code>DIAGNOSTICS -> DAC ZERO SCALE</code> menu items to force the Analog Output to a known output. Then, adjust your readout device, panel meter, PLC or data acquisition system to match.</p> <p>Check the output selection jumpers; see “Output Selection” on page 88.</p>
Auxiliary Function Pins Not Operating	<p>Make sure that the <code>AUX1 FUNCTION</code> or <code>AUX2 FUNCTION SETUP</code> menu items are set correctly; if they are set to <code>DISABLED</code> then they will not operate.</p> <p>The Auxiliary Function (“AUX1” and “AUX2”) pins must be connected to the DGND to activate them.</p>
Sensitivity to EMI/RFI	<p>To obtain maximum immunity to electromagnetic or radio frequency interference, make certain that the shields of the transducer cables are connected to the “cable shield connection screw” on the rear panel of the instrument. See “Connection of Four- or Five-wire AC/AC-LVDT” on page 74, “External Arrangement of Model SC500” on page 27.</p>
Non-linearity at the end of the LVDT’s mechanical range	<p>Most LVDTs have a usable measuring range that is smaller than their mechanical range. See “Electrical Null and Transducer Mounting” on page 87 for information on establishing the LVDT’s electrical null point to insure that the LVDT will be operated in its usable measuring range.</p>

12.1 Features

The High-Level Input channel provides a DC supply voltage to and accepts voltage or current signals from amplified transducers such as pressure transducers, load cells and DC-DC LVDTs. These signals are digitized, converted into engineering units, and placed into the track, peak and valley data values of the channel. Setup and calibration of the channel is made manually through the SETUP menu mode. *Signature Calibration* is not available with amplified transducers.

The analog-to-digital converter input circuit features adjustable digital, low-pass filtering, 12- to 18-bit resolution (depending on the filter setting) and has several different input ranges. These many ranges allow $\pm 50,000$ count resolution (at the slowest filter setting) across a wide variety of input ranges.

A combination of SETUP menu items and hardware jumpers are used to configure the excitation supply output voltage (+28 VDC, ± 15 VDC, +15 VDC or +12 VDC), the input type (voltage or current) and input reference (differential or single ended).

Two methods of calibrating the High-Level Input channel to the transducer are available: known-load calibration and shunt calibration. The benefits of each are discussed in "CALIBRATION TYPE Menu Item" on page 106.

Two rear panel control inputs can be field-configured for such functions as remote tare, disabling peak/valley detection and clearing the peak/valley values. A voltage or current digital-to-analog output is also provided.

12.2 Wiring

12.2.1 Channel Connector

Connect the amplified transducer, in-line amplifier or DC-DC LVDT to the Input Channel connector (the top connector of the instrument's rear panel). The Customer Information Sheet that shipped with the instrument describes which cards are installed in each channel. The pin-out for this connector is shown on the following table.

Table 1-11: High-Level Input Channel Pin Connections

Pin	Label	Function	Reference Pin	Availability
1 (left)	+EXC	(+)Excitation	10	standard
2	SHUNT1	Shunt Cal Relay	3	
3	SHUNT2	Shunt Cal Relay	2	
4	-EXC	(-)Excitation	10	standard
5	+SIG	(+)Signal	10	standard
6	-SIG	(-)Signal	10	standard
7	+OUT	Analog Output	8	Option 58i
8	-OUT	Analog Return	-	Option 58i
9	N/C	No Connection	-	
10	DGND	Digital Ground	-	standard
11	AUX1	Auxiliary Function 1 (connect to pin 10 to activate)	10	standard
12 (right)	AUX2	Auxiliary Function 2 (connect to pin 10 to activate)	10	standard

The DAC Output and DAC Return pins are electrically isolated from all other pins on the instrument.

CAUTION

Identify the amplified transducer or in-line amplifier according to the Option Code or model name as shown on the serial number tag. Use this information to select the correct wiring diagram on the following pages. Incorrect wiring can damage both the transducer and the instrument.

Failure to comply with these instructions may result in product damage.

12.2.2 Bi-polar Voltage Amplifiers

Use the following wiring diagram when connecting an amplified transducer, in-line amplifier or DC-DC LVDT with a bi-polar voltage amplifier to a High-Level Input channel. Examples of such devices include

- transducers with Option 2a or Option 2b internal amplifiers (with shunt cal)
- Models UBP or UBP-10 Universal In-Line amplifiers (with shunt cal)
- Models JEC (replaces model MDL), JEC-AG (replaces model DLA), JEC-C (replaces model MDLC), DW7U, DW7C and DW7S DC-DC LVDTs (no shunt cal)

NOTICE

See “Low Voltage DC-DC LVDTs” on page 99 for information on wiring Model DLB, DLE and DLF low-voltage DC-DC LVDTs.

The High-Level Input channel's Configuration Jumpers must be set as follows for proper operation. See “Excitation and Signal Jumpers” on page 100.

- (+)Excitation supply: “+15 VDC”
- (-)Excitation supply: “-15 VDC”
- Signal type: “voltage”
- Signal reference: “single ended”

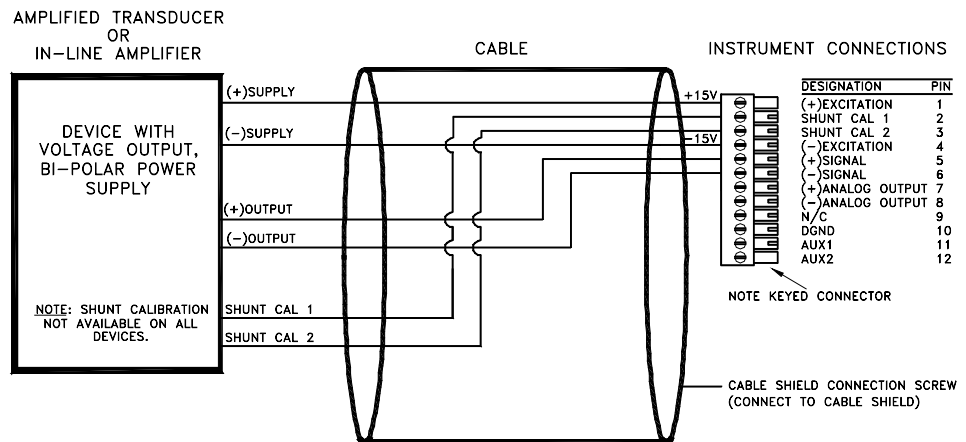

Figure 12-1: “Bi-polar Voltage Amp” Connection to High-Level Input Channel

12.2.3 "3-wire Voltage" Amplifiers

Use the following wiring diagram when connecting an amplified transducer or in-line amplifier with a 3-wire voltage amplifier to a High-Level Input channel. Examples of such devices include

- transducers with Option 2c or Option 2t internal amplifiers (with shunt cal)
- Models UV or UV-10 Universal In-Line amplifiers (with shunt cal)

The High-Level Input channel's Configuration Jumpers must be set as follows for proper operation. See "Excitation and Signal Jumpers" on page 100.

- (+)Excitation supply: "+28 VDC"
- (-)Excitation supply: "GND"
- Signal type: "voltage"
- Signal reference: "differential"

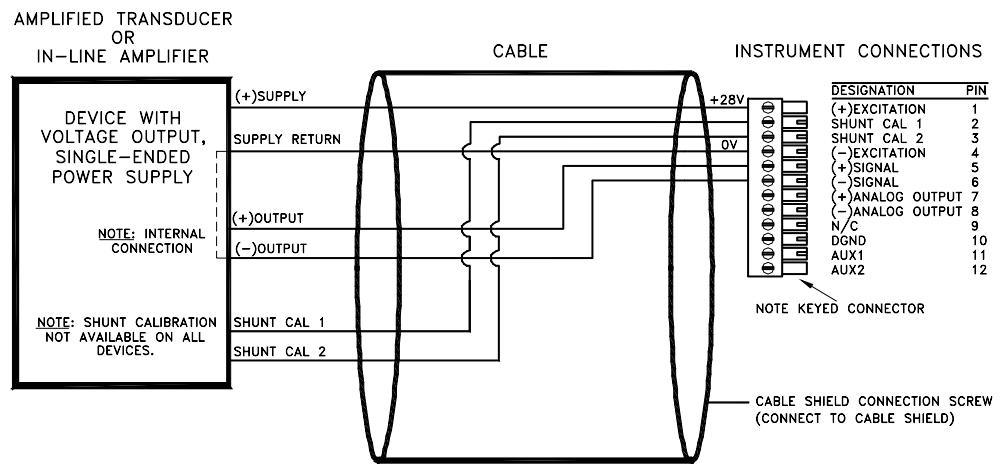

Figure 12-2: "3-wire Voltage Amp" Connection to High-Level Input Channel

12.2.4 "3-wire Voltage" Amplifiers with Single-wire Shunt Cal

Use the following wiring diagram when connecting an amplified transducer with a 3-wire voltage amplifier with single-wire shunt calibration to a High-Level Input channel. An example of a such device includes

- transducers with Option 2d or Option 2g internal amplifiers (with shunt cal)

The High-Level Input channel's Configuration Jumpers must be set as follows for proper operation. See "Excitation and Signal Jumpers" on page 100.

- (+)Excitation supply: "+28 VDC"
- (-)Excitation supply: "GND"
- Signal type: "voltage"
- Signal reference: "differential"

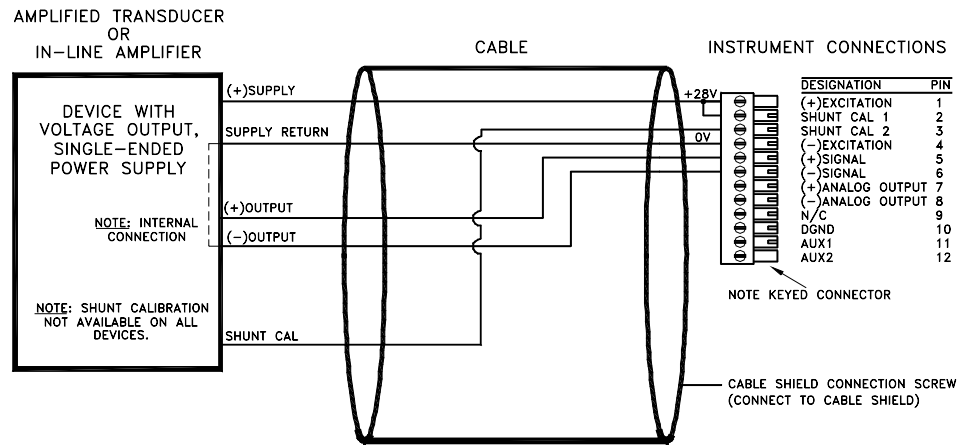

Figure 12-3: "3-wire Voltage Amp w/Single-Wire Shunt Cal" Connection to High-Level Input Channel

12.2.5 "3-wire Current" Amplifiers

Use the following wiring diagram when connecting an amplified transducer or in-line amplifier with a 3-wire current amplifier to a High-Level Input channel. Examples of such devices include

- transducers with the Option 2j internal amplifier (with shunt cal)
- Model U3W Universal In-Line amplifiers (with shunt cal)

The High-Level Input channel's Configuration Jumpers must be set as follows for proper operation. See "Excitation and Signal Jumpers" on page 100.

- (+)Excitation supply: "+28 VDC"
- (-)Excitation supply: "GND"
- Signal type: "current"
- Signal reference: "single ended"

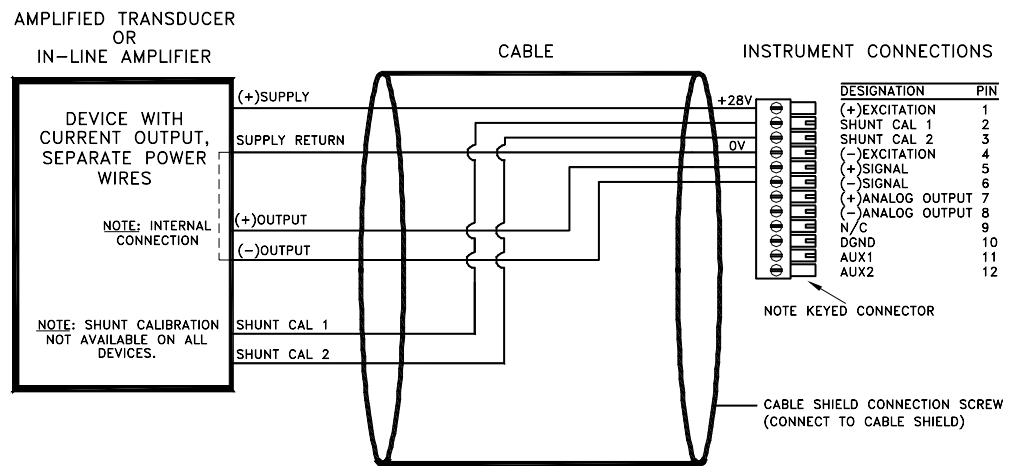

Figure 12-4: "3-wire Current Amp" Connection to High-Level Input Channel

12.2.6 "2-wire Current" Amplifiers with Buffered Shunt Cal

Use the following wiring diagram when connecting an amplified transducer or in-line amplifier with a 2-wire current amplifier to a High-Level Input channel. Examples of such devices include

- transducers with the Option 2k internal amplifier (not equipped with shunt cal)
- transducers with the Option 2k,3d internal amplifier (buffered shunt cal)
- Model U2W Universal In-Line amplifiers (not equipped with shunt cal)

The High-Level Input channel's Configuration Jumpers must be set as follows for proper operation. See "Excitation and Signal Jumpers" on page 100.

- (+)Excitation supply: "+28 VDC"
- (-)Excitation supply: "GND"
- Signal type: "current"
- Signal reference: "single ended"

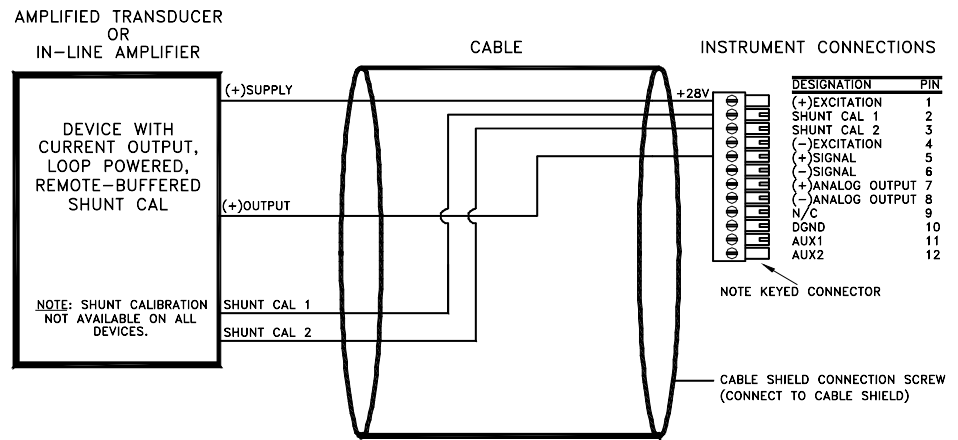

Figure 12-5: "2-wire Current Amp w/Buffered Shunt Cal" Connection to High-Level Input Channel

12.2.7 "2-wire Current" Amplifiers with Single-wire Shunt Cal

Use the following wiring diagram when connecting an amplified transducer or in-line amplifier with a 2-wire current amplifier to a High-Level Input channel. Examples of such devices include

- transducers with the Option 2p internal amplifier (not equipped with shunt cal)
- transducers with the Option 2p,3d internal amplifier (single-wire shunt cal)
- transducers with the Option 2y internal amplifier (not equipped with shunt cal)
- transducers with the Option 2y,3d internal amplifier (single-wire shunt cal)

The High-Level Input channel's Configuration Jumpers must be set as follows for proper operation. See "Excitation and Signal Jumpers" on page 100.

- (+)Excitation supply: "+28 VDC"
- (-)Excitation supply: "GND"
- Signal type: "current"
- Signal reference: "single ended"

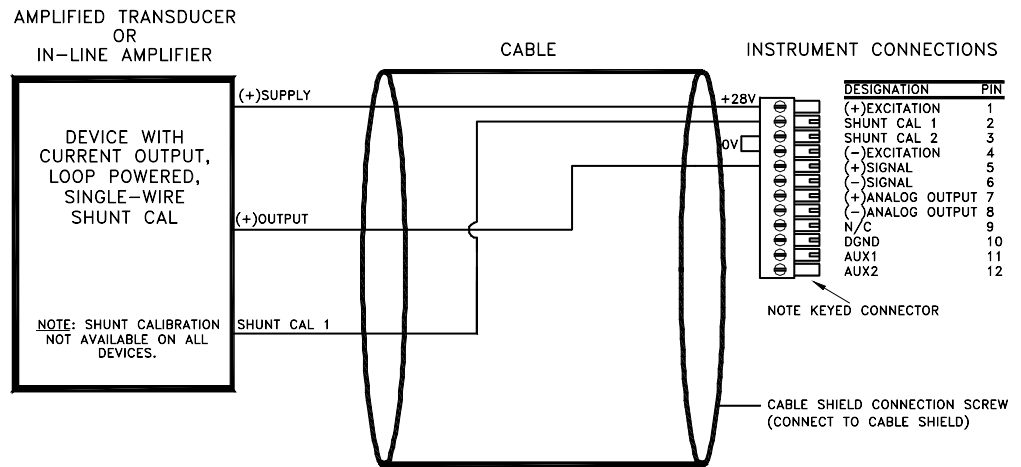

Figure 12-6: "2-wire Current Amp w/Single-Wire Shunt Cal" Connection to High-Level Input Channel

12.2.8 Low Voltage DC-DC LVDTs

Use the following wiring diagram when connecting a low-voltage DC-DC LVDT to a High-Level Input channel. Examples of such devices include

- Models DLB, DLE and DLF DC-DC LVDTs

The High-Level Input channel's Configuration Jumpers must be set as follows for proper operation. See "Excitation and Signal Jumpers" on page 100.

- (+)Excitation supply: "+12 VDC"
- (-)Excitation supply: "GND"
- Signal type: "voltage"
- Signal reference: "single ended"

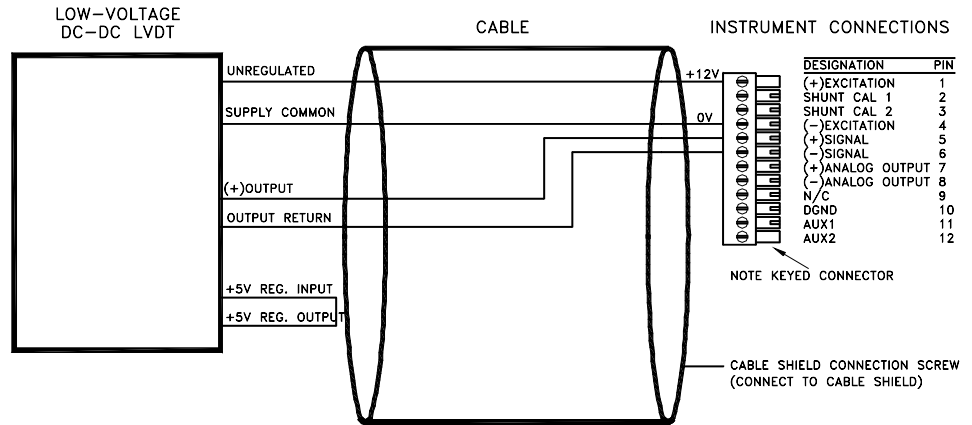

Figure 12-7: "Low Voltage" DC-DC LVDT Connection to High-Level Input Channel

12.3 Excitation and Signal Jumpers

12.3.1 Overview

The High-Level Input channel has hardware jumpers which allows configuration of excitation supply voltages and signal inputs to match a wide variety of amplified pressure, load and DC-DC LVDT transducers.

CAUTION

“Wiring” on page 92 explains the jumper settings required for a particular transducer type. Incorrect placement of the Excitation and Signal jumpers can damage both the transducer and the instrument.

Failure to comply with these instructions may result in product damage.

12.3.2 Setting Jumpers

Step 1: Remove the circuit board stack from the case. See “Case Removal” on page 29.

Step 2: Disconnect the Options Circuit Board from the Main Circuit Board. This will expose the jumpers on the bottom of the Main Circuit Board.

Step 3: Change the jumper settings according to the figure below.

Step 4: Re-connect the Options Board to the Main Circuit Board. Re-install the circuit board stack into the case.

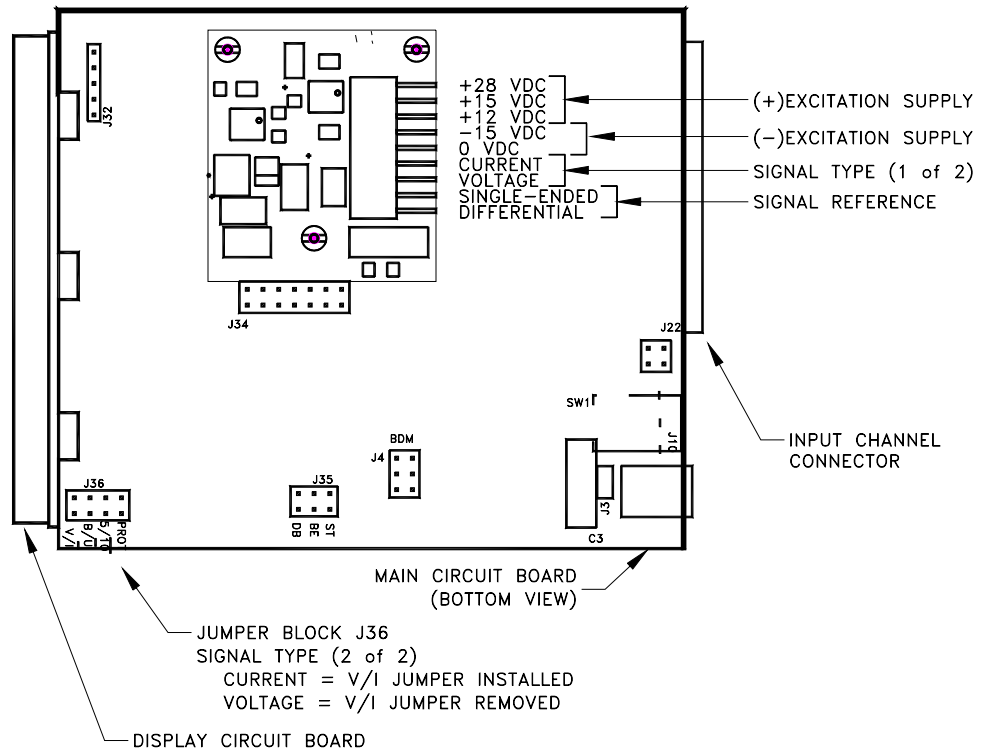

Figure 12-8: Excitation and Signal Jumper Locations on the High-Level Input Channel

CAUTION

There are two separate jumpers for the “signal type” whose settings must match.

Failure to comply with these instructions may result in product damage.

12.4 Calibration Procedure

If you are not familiar with operating the instrument in the SETUP menu mode, see “SETUP Menu mode” on page 23. A listing of all menu items is given in “Setup Menu Reference” on page 133.

Step 1: Wire the transducer to the channel’s connector.

See “Wiring” on page 92 for details.

Step 2: Set the Excitation and Signal jumpers appropriate for the transducer, amplifier or DC-DC LVDT.

See “Wiring” on page 92 and “Excitation and Signal Jumpers” on page 100.

Step 3: Enter the CALIBRATION TYPE.

There are two methods that can be used to calibrate the transducer to the Input Channel. Each has advantages and disadvantages as described in “CALIBRATION TYPE Menu Item” on page 106. It is important to know your application in order to select the appropriate calibration type.

Step 4: Enter the CALIBRATION DATA.

Otherwise, consult the Certificate of Calibration for the transducer when entering information in the CALIBRATION DATA sub-menu.

Step 5: Perform the calibration.

Using the CALIBRATE menu item starts the calibration process. You will be prompted to apply loads to the transducer as required.

12.5 Specifications

TRANSDUCER INPUT

Transducer types	amplified with voltage or current output, (field selectable)
Excitation Voltage	±15 VDC @ 40 mA max. +28 VDC @ 75 mA max. +12 VDC @ 40 mA max. (field selectable)
Excitation Overcurrent Protection	yes
Transducer full-scale output	±1, ±5, ±10 VDC 4-20 mA (field selectable)
Calibration Type	shunt, or 2-, 3- or 5- point known load
A/D Converter	24-bit Sigma-Delta
Low-pass filter	digital, 24-tap FIR
Resolution and Frequency Response	see "FREQ. RESPONSE Menu Item" on page 103

INSTRUMENT-ONLY ACCURACY

(Frequency Response setting ≤ 16Hz; Linearity, repeatability & hysteresis)

Known -Load Calibration	±0.01% F.S.
-------------------------	-------------

AUXILLIARY INPUTS

Quantity	2
Type	momentary contact closure
Response Time	< 5ms
Field-Selectable Functions	tare on, tare off, peak/valley clear, peak/valley hold, track hold

DIGITAL-TO-ANALOG OUTPUT

Availability	with Option 58i
Output voltage range	5, ±5, 10 or ±10 VDC (field selectable)
Source	any channel's track, peak or valley value
Isolation	500V
Resolution	14 bits
Frequency Response	same as input when driven by the same channel's tracking data

12.6 Channel Menu

Each High-Level Input channel is configured and calibrated via its channel menu. Detailed instructions on operating the instrument in the SETUP Menu mode can be found in "SETUP Menu mode" on page 23. A diagram of all menus is located in "Setup Menu Reference" on page 133.

12.6.1 OPERATION Sub-Menu

This menu controls the operation of this channel when the instrument is in the RUN mode.

AUTO-ZERO Menu Item

This enables or disables the channel's automatic zeroing function. The auto-zero function can remove the effect of slight temperature shifts in the transducer's output. The two options for this menu item are "ON" and "OFF".

When enabled, the channel will reset its tracking value to zero when the tracking value has never been more positive than +10 or more negative than -10 display counts for any 10 second period.

For example, assume that the DISPLAY.DECPT menu item is set to 000.00 (two decimal points). If the tracking value never leaves the range of -000.10 to +000.10 for any 10 second period, then tracking value will reset to 000.00 automatically.

NOTICE

To compensate for the transducer's initial warm-up shift, the auto-zero function operates every 2 seconds during the first 60 seconds of RUN mode operation.

FREQ. RESPONSE Menu Item

This sets the frequency response, step response, and resolution of the channel according to the table below. The tracking value, peak/valley detector values and DAC Output are all affected. The default value of 016. HERTZ is suitable for most applications.

Frequency Response	Step Response (ms) (typical)	Resolution (counts) (not including min. 10% overrange/underrange capability)	
		5V & 10V Inputs	1V & 4-20mA Inputs
002. HERTZ/FAST	40	±50000	±50000
002. HERTZ	440	±50000	±50000
008. HERTZ	110	±25000	±25000
016. HERTZ	55	±25000	±20000
032. HERTZ	28	±20000	±10000
050. HERTZ	16	±15000	±10000
100. HERTZ	8	±10000	±5000
250. HERTZ	3	±10000	±5000

POWER-ON SOURCE Menu Item

This menu selects which value is displayed by the channel when first entering the RUN mode.

The choices are:

- "TRACK" means the live tracking value of the channel.
- "PEAK" means the highest value of the channel.
- "VALLEY" means the lowest value of the channel.

12.6.2 DISPLAY SETUP Sub-Menu

This menu controls how data values are displayed by the channel and transmitted via serial communications.

DISPLAY. DIGITS Menu Item

Selects the number of digits displayed by the channel. The choices are:

- "5 DIGIT-BIPOLAR" displays both positive and negative numbers with five full digits (± 99999).
- "6 DIGIT-UNIPLAR" displays positive numbers with six full digits (999999) and negative numbers with five full digits (-99999).
- "7 DIGIT UNIPOLAR" displays positive number with seven full digits (9999999) and negative numbers with six digits (-999999).

DISPLAY. DECPY Menu Item

Selects the decimal point location on the channel's display and serial communications output. Use the [UP] and [DOWN] buttons to move the decimal point to the right and left.

This menu item may be automatically updated by a transducer's *Signature Module*.

DISPLAY. COUNT-BY Menu Item

Determines by what value the display increments or decrements. This will make the display less sensitive to a noisy signal. The choices are:

- "00001"
- "00002"
- "00005"
- "00010"
- "00020"
- "00050"
- "00100"
- "00200"

DISPLAY. UNITS Menu Item

Specifies the four character label that is displayed to the right of the channel's values.

NOTICE

This menu item doesn't change the mathematical scaling of the channel's values; that can be changed by altering the "CALIBRATION DATA -> FULL SCALE VALUE" menu item and then performing a re-calibration.

This menu item doesn't change the mathematical scaling of the channel's values; that can be changed by altering the "CALIBRATION DATA -> FULL SCALE VALUE" menu item and then performing a re-calibration.

When a character position is flashing press the [UP] or [DOWN] button to change the character. Press [ENTER] to advance to the next character.

DISPLAY. AVERAGE Menu Item

Controls the speed with which the channel's display values will update. Display averaging does not affect the DAC Output or peak/valley detection, which will proceed at the speed selected by the "OPERATION -> FREQ. RESPONSE" menu item. The choices are:

- "ON" means that the display will update four times each second. The channel's values will be averaged for 1/4 second, then displayed.
- "OFF" means that the channel's display will update as quickly as possible.

12.6.3 AUX_n FUNCTION Menu Items

The AUX1 FUNCTION and AUX2 FUNCTION menu items determine what happens when the Auxiliary Function pins (labeled as “AUX1” and “AUX2”) on the Input Channel connector are activated. These pins are “activated” when connected to the DGND pin. The choices are:

- “DISABLED” means that activating the pin does nothing.
- “TRACK HOLD” means that the tracking, peak and valley values will not be updated.
- “HIGH/LOW HOLD” means that the peak and valley values will not be updated.
- “HIGH/LOW CLEAR” means that the peak and valley values are reset.
- “TARE ON” activates the channel’s Tare function (resets it to zero) .
- “TARE OFF” deactivates the channel’s Tare function.

As the Auxiliary Function pins are not isolated, it is recommended that a push-button switch or relay is used to connect these pins to the DGND pin.

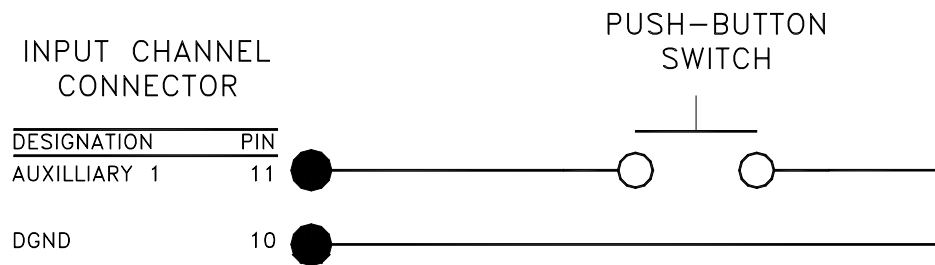

Figure 12-9: Auxilliary Input Example

NOTICE

A SensoCode program running on a Mathematics Virtual Channel may override the default behavior of the Auxilliary Function inputs. Consult the Customer Information Sheet included with your instrument for details.

**12.6.4 CALIBRATION
TYPE Menu Item**

This chooses the type of calibration technique to be used. There are two methods that can be used to calibrate the transducer to the Input Channel. Each has advantages and disadvantages as described in the table below.

Table 1-12: Comparison of Calibration Types

	Shunt Calibration	2-, 3-, or 5-point Known Load Calibration
RECOMMENDED...		
...for most applications	no	yes
...when frequently swapping transducers	yes	no
...when best possible accuracy required	no	yes
PROS and CONS		
Relative accuracy	good	best
Requires actual, calibrated loads to be applied	no	yes
CALIBRATION TECHNIQUE		
Zero-scale point from...	applied load	applied load
Full-scale point from...	transducer output when Shunt Cal pins connected	applied load
Linearity correction from...	N/A	2-point: none 3- or 5-point: applied load

It is important to know your application in order to select the appropriate calibration type. When the best possible accuracy is required, Known-Load Calibration is recommended. However, if known-loads are not available, Shunt Calibration may be used instead.

The choices for this menu item are:

- “TYPE= SHUNT CAL” means Shunt Calibration. First, you are prompted to apply the load entered in the “ZERO SCALE VALUE” register. Next, the instrument interconnects the Shunt Cal 1 and Shunt Cal 2 pins. This activates the transducer’s or in-line amplifier’s shunt calibration circuit which causes a predictable apparent signal. The instrument then takes a reading and adjusts itself using the “SHUNT CAL VALUE” register.
- “TYPE= 2 POINT CAL” means 2-Point Known Load Calibration. You are prompted to apply the loads to the transducer that were entered in the “KNOWN POINT 1/2” and “KNOWN POINT 2/2” registers. This technique assumes that the transducer is linear, so the usual loads used are zero scale and full scale.
- “TYPE= 3 POINT CAL” means 3-Point Known Load Calibration. You are prompted to apply the loads to the transducer that were entered in the “KNOWN POINT 1/3” and “KNOWN POINT 2/3” and “KNOWN POINT 3/3” registers. This technique can be used to

- compensate for the non-linearity in the transducer. The usual loads used are zero scale, half scale and full scale, but you are not restricted to these loads.
- "TYPE= 5 POINT CAL" means 5-Point Known Load Calibration. You are prompted to apply the loads to the transducer that were entered in the "KNOWN POINT 1/5", "KNOWN POINT 2/5", "KNOWN POINT 3/5", "KNOWN POINT 4/5" and "KNOWN POINT 5/5" registers. This technique can be used to compensate for the non-linearity in the transducer. The usual loads used are zero scale, one-quarter scale, half scale, three-quarters scale and full scale, but you are not restricted to these loads.
- The selection of the calibration type affects what menu items appear in the CALIBRATION DATA sub-menu.

12.6.5 CALIBRATION DATA Sub-Menu

FULL SCALE VOLT or
FULL SCALE CURR Menu Item

This enters the values that will be used by the instrument when it calibrates itself to the transducer. The menu items that are displayed will change according to what the CALIBRATION TYPE is set for.

The nominal transducer/amplifier output when its full-scale load is applied to it, in volts or milliamps. This menu item is used by the instrument to set gain of its amplifier circuit. This value is normally found on the transducer's Certificate of Calibration or amplifier's Application Note.

FULL SCALE VALUE Menu Item

The transducer's full-scale output in engineering units.
It is available only with the Shunt Calibration type.

ZERO SCALE VALUE Menu Item

The transducer's zero-scale output in engineering units, which is usually zero.
It is available only with the Shunt Calibration type.

SHUNT CAL VALUE Menu Item

The shunt calibration value must be calculated by using information found on the transducer's Certificate of Calibration and the following formula:

$$\text{SHUNT CAL VALUE} = \frac{\text{Shunt-Calibration Output}}{\text{Full-Scale Output}} \times \text{Full-Scale Capacity}$$

The terms have the following meanings:

- *Shunt-Calibration Output*: The transducer's output when its shunt calibration function is activated in Volts or milliamps. Sometimes called "Shunt Cal. Factor".
- *Full-Scale Output*: The transducer's full-scale output in Volts or milliamps. Sometimes called "Calibration Factor".
- *Full-Scale Capacity*: The transducer's desired full-scale reading in engineering units (PSI, lbs, Kg, etc.). You may wish to convert the engineering units of this value. For example, if the transducer full scale is 3000 PSIG and you wish the channel to read in bar, you must convert 3000 PSIG into 206.84 bar.

This menu item is only available with the Shunt Calibration type.

To verify proper transducer/amplifier operation, you can activate the transducer's/amplifier's shunt calibration function while the instrument is in the RUN mode. Press and hold the [ENTER] button for three seconds; this will activate the transducer's/amplifier's shunt calibration function and display the reading.

KNOWN POINT x/y Menu Items

This enters the engineering units for the known-load calibration points. These points must match the actual loads that you will apply to the instrument during calibration. The number of calibrations points depends on the CALIBRATION TYPE.

When using the 2-Point Known Load Calibration type, the following menu items are available:

- "KNOWN POINT 1/2": point 1 of 2, usually 0% of the transducer's full-scale capacity.
- "KNOWN POINT 2/2": point 2 of 2, usually 100% of the transducer's full-scale capacity.

When using the 3-Point Known Load Calibration type, the following menu items are available:

- "KNOWN POINT 1/3": point 1 of 3, usually 0% of the transducer's full-scale capacity.

- ity.
- "KNOWN POINT 2/3": point 2 of 3, usually 50% of the transducer's full-scale capacity.
- "KNOWN POINT 3/3": point 3 of 3, usually 100% of the transducer's full-scale capacity.

When using the 5-Point Known Load Calibration type, the following menu items are available:

- "KNOWN POINT 1/5": point 1 of 5, usually 0% of the transducer's full-scale capacity.
- "KNOWN POINT 2/5": point 2 of 5, usually 25% of the transducer's full-scale capacity.
- "KNOWN POINT 3/5": point 3 of 5, usually 50% of the transducer's full-scale capacity.
- "KNOWN POINT 4/5": point 4 of 5, usually 75% of the transducer's full-scale capacity.
- "KNOWN POINT 5/5": point 5 of 5, usually 100% of the transducer's full-scale capacity.

NOTICE

To insure both correct operation of the transducer and application of the load, the instrument expects the voltage or current applied at each known-load point to be increasing. For example, the load applied at Known-Load Point 2/2 must cause the transducer to produce a more positive voltage or current than at Known-Load Point 1/2.

These menu items are only available with the Known-Load Calibration types.

12.6.6 CALIBRATE Menu Item

This menu item performs a calibration according to what was entered in the CALIBRATION TYPE and CALIBRATION DATA menu items.

NOTICE

Before performing a calibration,

- the transducer must be connected to the instrument,
- the channel's Excitation and Signal Jumpers must be set,
- the CALIBRATION TYPE must be selected (see "CALIBRATION TYPE Menu Item" on page 106), and
- the CALIBRATION DATA must be entered (see "CALIBRATION DATA Sub-Menu" on page 108).

NOTICE

For maximum accuracy, allow at least twenty minutes of warm-up with the excitation voltage applied to the transducer before calibration.

If the CALIBRATION TYPE is **Shunt Calibration...**

- The display will read `DOING SHUNT CAL`, and prompt you to `APPLY 00000 UNIT` (where 00000 and UNIT are previously entered as ZERO SCALE VALUE and DISPLAY. UNITS). When you have applied this load to the transducer, press [ENTER].
- The display will then read `WORKING` and calibration will take place. Upon completion, the display will indicate `DONE` and the instrument will return to the RUN mode.

If the CALIBRATION TYPE is **2-Point Known Load Calibration...**

- The display will read `DOING 2POINT CAL`, and prompt you to `APPLY 00000 UNIT` (where 00000 and UNIT are previously entered as KNOWN POINT 1/2 and DISPLAY. UNITS). When you have applied this load to the transducer, press [ENTER].
- The display will read `WORKING`, then `APPLY 01000 UNIT` (where 01000 and UNIT are previously entered as KNOWN POINT 2/2 and DISPLAY. UNITS). When you have applied this load to the transducer, press [ENTER].
- Upon completion, the display will indicate `DONE` and the instrument will return to the RUN mode.

If the CALIBRATION TYPE is **3-Point Known Load Calibration...**

- The display will read `DOING 3POINT CAL`, and prompt you to `APPLY 00000 UNIT` (where 00000 and UNIT are previously entered as KNOWN POINT 1/3 and DISPLAY. UNITS). When you have applied this load to the transducer, press [ENTER].
- The display will read `WORKING`, then `APPLY 00500 UNIT` (where 00500 and UNIT are previously entered as KNOWN POINT 2/3 and DISPLAY. UNITS). When you have applied this load to the transducer, press [ENTER].
- The display will read `WORKING`, then `APPLY 01000 UNIT` (where 01000 and UNIT are previously entered as KNOWN POINT 3/3 and DISPLAY. UNITS). When you have applied this load to the transducer, press [ENTER].
- Upon completion, the display will indicate `DONE` and the instrument will return to the RUN mode.

If the CALIBRATION TYPE is **5-Point Known Load Calibration...**

- The display will read `DOING 5POINT CAL`, and prompt you to `APPLY 00000 UNIT` (where 00000 and UNIT are previously entered as `KNOWN POINT 1/5` and `DISPLAY. UNITS`). When you have applied this load to the transducer, press [ENTER].
- The display will read `WORKING`, then `APPLY 00250 UNIT` (where 00250 and UNIT are previously entered as `KNOWN POINT 2/5` and `DISPLAY. UNITS`). When you have applied this load to the transducer, press [ENTER].
- The display will read `WORKING`, then `APPLY 00500 UNIT` (where 00500 and UNIT are previously entered as `KNOWN POINT 3/5` and `DISPLAY. UNITS`). When you have applied this load to the transducer, press [ENTER].
- The display will read `WORKING`, then `APPLY 00750 UNIT` (where 00750 and UNIT are previously entered as `KNOWN POINT 4/5` and `DISPLAY. UNITS`). When you have applied this load to the transducer, press [ENTER].
- The display will read `WORKING`, then `APPLY 01000 UNIT` (where 01000 and UNIT are previously entered as `KNOWN POINT 5/5` and `DISPLAY. UNITS`). When you have applied this load to the transducer, press [ENTER].
- The display will now read `RETURN PNTS. =NO`. If you press [ENTER], the display will indicate `DONE` and the instrument will return to the RUN mode. If you use the [UP] button and [ENTER] to select `RETURN POINTS=YES`, you may now apply the same loads again but in reverse order. This will allow the instrument to measure and partially eliminate any hysteresis that may be present in the transducer. After the loads have been applied again, the display will indicate `DONE` and the instrument will return to the RUN mode.

12.6.7 DAC SETUP Sub-Menu

This sub-menu contains four items that control the Digital-to-Analog Converter (DAC) Output of the Input Channel.

The DAC Output is only available if the instrument was purchased with Option 58i.

DAC. CHANNEL Menu Item

This chooses which channel will drive the DAC Output. Normally, the DAC Output is driven by the Input Channel (Channel 01), but that need not be the case. For example, a Mathematics Virtual channel installed as Channel 02 could drive the Input Channel's DAC Output.

DAC. SOURCE Menu Item

This designates the data source of the channel monitored by the DAC Output.

The options for this menu item are:

- "TRACK" means the live tracking value of the channel.
- "PEAK" means the highest value of the channel since the peak/valley detector was last cleared.
- "VALLEY" means the lowest value of the channel since the peak/valley detector was last cleared.

DAC. ZERO-SCALE Menu Item

This specifies what value, in engineering units, corresponds to zero output on the DAC Output.

"Zero output" might be 0 Volts, 2.5 Volts or 5 Volts depending on how the DAC Output is configured. See "Digital-to-Analog (DAC) Output Configuration" on page 114 for details.

DAC. FULL-SCALE Menu Item

Specifies what value, in engineering units, corresponds to full output on the DAC Output.

"Full output" might be 5 Volts or 10 Volts depending on how the DAC Output is configured. See "Digital-to-Analog (DAC) Output Configuration" on page 114 for details.

12.6.8 DIAGNOSTICS

Sub-Menu

DAC FULL SCALE Menu Item	When this menu item is selected, the DAC Output is forced to its full-scale output, then <code>DAC UPDATED</code> is displayed. This is useful when calibrating or trimming the readout connected to the DAC Output.
DAC ZERO SCALE Menu Item	When this menu item is selected, the DAC Output is forced to its zero-scale output, then <code>DAC UPDATED</code> is displayed. This is useful when calibrating or trimming the readout connected to the DAC Output.
VERSION INFO Menu Item	This menu item displays the part number and revision level of the firmware used by this channels microprocessor.
DISPLAY ADC Menu Item	<p>The options for this menu item are:</p> <ul style="list-style-type: none">• “OFF” will allow the [VALUE] button to cycle through “TK” (tracking value), “HI” (peak value) and “LO” (valley value). This is the recommended option.• “ON” will allow the “AD” (percentage of the Analog-to-Digital converter’s full-scale digitizing capability) display source to be available along with “TK” (tracking value), “HI” (peak value) and “LO” (valley value) when the [VALUE] button is pressed on the front panel. <p>The Analog-to-Digital converter counts are displayed as a percentage from -100.00% to 100.00%.</p> <p>This can be used to verify that the transducer’s output does not exceed the input range of the instrument. If the Analog-to-Digital converter readings display more than +/-10% when there is no load on the transducer, the transducer has a high zero offset.</p>
LINEARIZATION Menu Item	<p>The options for this menu item are:</p> <ul style="list-style-type: none">• “ON” will allow linearization data obtained from either the Signature Module or a 3-Point or 5-Point Known Load Calibration to affect a channel’s scaled values. This is the recommended option.• “OFF” will not allow linearization data to effect the channel’s scaled values. This is useful when diagnosing problems in a calibration procedure.
DISABLE CHANNEL Menu Item	<p>The options for this menu item are:</p> <ul style="list-style-type: none">• “ON” will bypass the INITIALIZE and RUN modes of the channel. The track, peak and valley values of the channel are forced to 0. This option is helpful when a channel is installed but not being used.• “OFF” will allow normal operation of the channel.

12.7 Digital-to-Analog (DAC) Output Configuration

12.7.1 Channel Menu Items The DAC Output can be driven by any channel's track, peak or valley value. See the "Channel Menu" section earlier in this chapter for a complete listing of SETUP menu items available on the DAC. SETUP sub-menu.

12.7.2 Output Selection Jumpers located on the Main Circuit Board determine what outputs are generated when the value selected to drive the DAC Output (from the DAC. CHANNEL and DAC. SOURCE menu items) equals the DAC. FULL SCALE and DAC. ZERO SCALE settings.

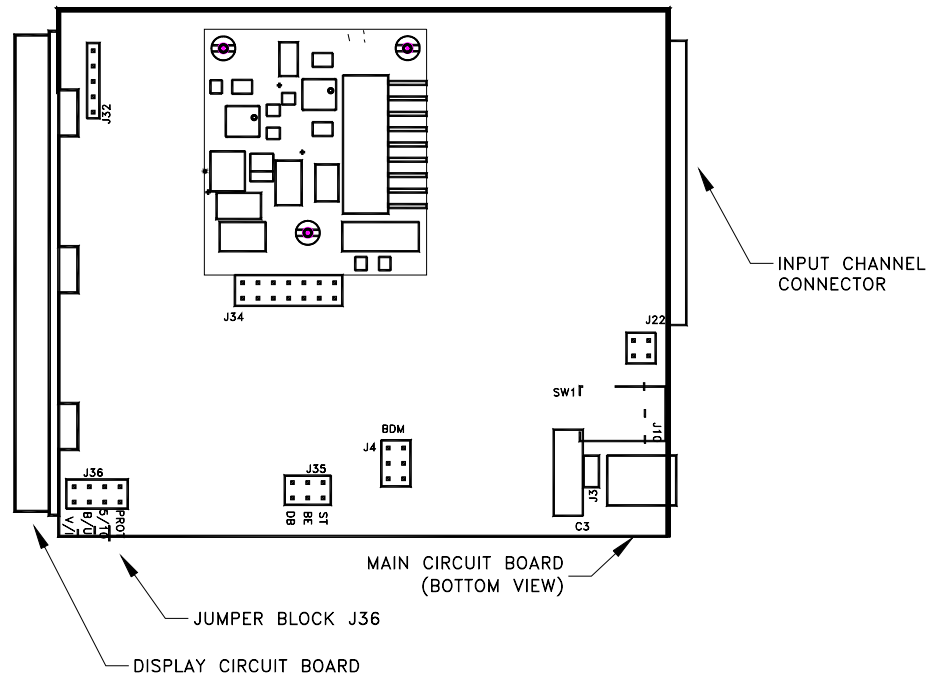

Figure 12-10: Digital-to-Analog Output Jumper Locations

	DAC. ZERO SCALE Output	DAC. FULL SCALE Output	<u>Jumper Block J36</u>	
			<u>5/10 jumper</u>	<u>B/U jumper</u>
0-5V	2.5 Volts	5 Volts	closed	open
±5V	0 Volts	5 Volts	closed	closed
0-10V	5 Volts	10 Volts	open	open
±10V	0 Volts	10 Volts	open	closed

12.8 Troubleshooting

12.8.1 Error Messages

See “Error Messages” on page 127 for information relating to error messages.

12.8.2 Common Problems and Solutions

Erratic Display

Check electrical connections for continuity and the transducer’s and/or amplifier’s wiring code from its Certificate of Calibration and Application Note.

Incorrect wiring may have shorted the excitation power supply. Use the correct wiring diagram to connect the transducer or amplifier to the instrument.

Make sure that the load on the transducer is constant.

Check input voltage or current to the (+)Signal (“+SIG”) and (-)Signal (“-SIG”) pins with a multi-meter.

Blank Display

Incorrect wiring may have shorted the ± 15 VDC excitation power supply. Use the correct wiring diagram to connect the transducer or amplifier to the instrument.

+OVLD or -OVLD on Display

Indicates that the voltage across the (+)Signal (“+SIG”) and (-)Signal (“-SIG”) pins is overranging or underranging the amplifier circuit. Make certain all wires are connected properly.

If you remove all load from the transducer and you still see this message, the (+)Excitation (“+EXC”) or (-)Excitation (“-EXC”) pins may be shorted to the (+)Signal (“+SIG”) or (-)Signal (“-SIG”) pins.

If you remove all load from the transducer and you get a numeric reading, the transducer may have a high zero offset. Use the channel’s SETUP menu and set `DIAGNOSTICS -> DISPLAY ADC` to “ON”; in the RUN mode this will allow the [VALUE] button to display raw A/D readings as a percentage of its full-scale. If the raw A/D readings display more than $\pm 10\%$ when there is no load on the transducer, the transducer has a high zero offset.

DAC Output Incorrect

The DAC Output is only available on instruments ordered with Option 58i.

Use the `DIAGNOSTICS -> DAC FULL SCALE` and `DIAGNOSTICS -> DAC ZERO SCALE` menu items to force the Analog Output to a known output. Then, adjust your readout device, panel meter, PLC or data acquisition system to match.

Check the output selection jumpers; see “Output Selection” on page 114.

Auxiliary Function Pins Not Operating

Make sure that the `AUX1 FUNCTION` or `AUX2 FUNCTION SETUP` menu items are set correctly; if they are set to `DISABLED` then they will not operate.

The Auxiliary Function (“AUX1” and “AUX2”) pins must be connected to the DGND pin to activate them.

Sensitivity to EMI/RFI

To obtain maximum immunity to electromagnetic or radio frequency interference, make certain that the shields of the transducer cables are connected to the “cable shield connection screw” on the rear panel of the instrument. See “Wiring” on page 92 and “External Arrangement of Model SC500” on page 27.

13.1 Features

The Split Display Virtual Channel allows the display of two track, peak or valley values from any two channels at the same time. One value is displayed on the left side of the display, and another value is displayed on the right side.

The display setup used to format each value is inherited from the source channel of the value.

13.2 Wiring

A Virtual Channel exists in software only; it does not occupy a physical slot inside of the instrument's chassis. However, a Virtual Channel does require a channel number.

There is no rear-panel connector for a Virtual Channel.

13.3 Setup Procedure

If you are not familiar with operating the instrument in the SETUP menu mode, see "SETUP Menu mode" on page 23. A listing of all menu item is given in "Setup Menu Reference" on page 133.

Step 1: Enter the value to be displayed on the left side with `LEFT CHANNEL` and `LEFT SOURCE`.

Step 2: Enter the value to be displayed on the right side with `RIGHT CHANNEL` and `RIGHT SOURCE`.

13.4 Channel Menu

Detailed instructions on operating the instrument in the SETUP Menu mode can be found in “SETUP Menu mode” on page 23. A diagram of all menus is located in “Setup Menu Reference” on page 133.

LEFT CHANNEL Menu Item	This specifies the channel that is displayed on the left half of the split display.
LEFT SOURCE Menu Item	<p>This lets you designate the data source of the channel monitored by the left half of the split display. Each channel has three data sources: the live tracking value (TRACK), its highest value (PEAK), and its lowest value (VALLEY).</p> <p>The options for this menu item are:</p> <ul style="list-style-type: none">• “TRACK” means the live tracking value of the channel.• “PEAK” means the highest value of the channel since the peak detector was last cleared.• “VALLEY” means the lowest value of the channel since the valley detector was last cleared.
RIGHT CHANNEL Menu Item	This specifies the channel that is displayed on the right half of the split display.
RIGHT SOURCE Menu Item	<p>This lets you designate the data source of the channel monitored by the right half of the split display. Each channel has three data sources: the live tracking value (TRACK), its highest value (PEAK), and its lowest value (VALLEY).</p> <p>The options for this menu item are:</p> <ul style="list-style-type: none">• “TRACK” means the live tracking value of the channel.• “PEAK” means the highest value of the channel since the peak detector was last cleared.• “VALLEY” means the lowest value of the channel since the valley detector was last cleared.
LEAVE MENU Menu Item	When the menu item is displayed, press [ENTER] to leave this menu. Press [EXIT] to return to the RUN mode.

13.5 Troubleshooting

Front Panel Buttons not Operating in RUN Mode	When a Split Display Virtual channel is displayed the [VALUE], [CLEAR] and [TARE] buttons have no effect. To change one of the values shown on a Split Display Virtual channel, use the its SETUP menu. To clear peak/valley values or tare an Input channel, use the [CHANNEL] button to select an Input channel and then use the [CLEAR] or [TARE] buttons.
--	---

14.1 Features

The Mathematics Virtual Channel is a powerful, flexible means to allow SC Series Instruments to perform simple to moderate functions that previously required the use of expensive programmable logic controllers (PLC).

A Mathematics Virtual Channel is akin to a PLC; it can execute programs written in an interpretive language called SensoCode. At the time of order, your specific application is analyzed by our sales and engineering staff and one or more SensoCode programs are created. These SensoCode programs are loaded into the Mathematics Virtual channels of the instrument at the factory. The end result is an instrument that meets your specific needs but is built with “off-the-shelf” hardware and software.

SensoCode programs allow the instrument to perform a variety of functions including:

- **Mathematics:** addition, subtraction, multiplication, division, square roots, etc.
- **Logical:** if/then condition statements, comparison of values
- **Timing**
- **Input:** from any channel's track, peak or valley values, open-collector inputs, constant user-entered values from the SETUP menu
- **Output:** Each Mathematics Channel generates its own track, peak, and valley values. A SensoCode program can “take control” of the Limit Output and/or front panel indicator lights.

14.2 Wiring

A Virtual Channel exists in software only; it does not occupy a physical slot inside of the instrument's chassis. However, a Virtual Channel does require a channel number.

A SensoCode program that is executed by a Mathematics Virtual Channel can use the System connector's Limit Output pins and Function Input pins for its own purposes. Consult the Customer Information Sheet and Supplemental Instructions included with the particular instrument for details.

14.3 Setup Procedure

If you are not familiar with operating the instrument in the SETUP menu mode, see “SETUP Menu mode” on page 23. A listing of all menu item is given in “Setup Menu Reference” on page 133.

Step 1: Examine the Supplemental Instructions.

Supplemental Instructions contain important information about what each Mathematics Channel does and what Function Inputs and/or Limit Output pins of the System connector are used.

Step 2: Wire to the pins on the System connector.

See “Options Connector” on page 31. It is important to read the Supplemental Instructions to determine the wiring for your application.

Step 3: Verify operation.

14.4 Channel Menu

Each Mathematics Virtual Channel can have its configuration and SensoCode programming examined via its channel menu. It is not possible to alter the SensoCode program with the SETUP menu. Detailed instructions on operating the instrument in the SETUP Menu mode can be found in “SETUP Menu mode” on page 23. A diagram of all menus is located in “Setup Menu Reference” on page 133.

14.4.1 SENSOCODE P/N Menu Item

This menu item displays the part number and revision level of the SensoCode program loaded in this Mathematics Virtual Channel.

14.4.2 USER VALUES Sub-Menu

This sub-menu contains menu items for each of the User Values. User Values are constant numeric values that can be edited by the user and read by a SensoCode program. The use of each User Value depends on the SensoCode program loaded in the Mathematics Virtual Channel.

By default, the four items on this menu are USER VALUE 1, USER VALUE 2, USER VALUE 3 and USER VALUE 4. However, a SensoCode program can alter the menu item text for each of the User Values to make them more relevant to the operator. For example, USER VALUE 1 might be re-titled JELLY BEAN COUNT.

14.4.3 VIEW SENSOCODE Menu Item

This menu item allows the display of each “step” (either an operand or an instruction) of the SensoCode program presently loaded into a Mathematics Virtual Channel. Pressing [ENTER] will display the next step of the SensoCode program until the entire program has been viewed.

SensoCode programs cannot be altered with the SETUP Mode menu; they can only be loaded via the serial port with the Instrument Utility Software.

14.4.4 VIEW COMMANDS Sub-Menu

This sub-menu contains menu items for each of the Command Strings that can be used by a SensoCode program. Command Strings are text constants that can be read by a SensoCode program. They are not able to be changed with the SETUP menu. The use of each Command String depends on the SensoCode program loaded in the Mathematics Virtual Channel.

The items on this menu are COMMAND 0, COMMAND 1, COMMAND 2, COMMAND 3, COMMAND 4, COMMAND 5, COMMAND 6, and COMMAND 7.

14.4.5 DISPLAY SETUP Sub-Menu

This menu controls how data values are displayed by the channel and transmitted via serial communications.

DISPLAY. DIGITS Menu Item

Selects the number of digits displayed by the channel. The choices are:

- "5 DIGIT-BIPOLAR" displays both positive and negative numbers with five full digits (± 99999).
- "6 DIGIT-UNIPLAR" displays positive numbers with six full digits (999999) and negative numbers with five full digits (-99999).
- "7 DIGIT UNIPOLAR" displays positive number with seven full digits (9999999) and negative numbers with six digits (-999999).

DISPLAY. DECPY Menu Item

Selects the decimal point location on the channel's display and serial communications output. Use the [UP] and [DOWN] buttons to move the decimal point to the right and left.

DISPLAY. COUNT-BY Menu Item

Determines by what value the display increments or decrements. This will make the display less sensitive to a noisy signal. The choices are:

- "00001"
- "00002"
- "00005"
- "00010"
- "00020"
- "00050"
- "00100"
- "00200"

DISPLAY. UNITS Menu Item

Specifies the four character label that is displayed to the right of the channel's values. This menu item doesn't change the mathematical scaling of the channel's values; that is determined by the "CALIBRATION DATA -> FULL SCALE VALUE" menu item.

When a character position is flashing press the [UP] or [DOWN] button to change the character. Press [ENTER] to advance to the next character.

DISPLAY. AVERAGE Menu Item

Controls the speed with which the channel's display values will update. The choices are:

- "ON" means that the display will update four times each second. The channel's values will be averaged for 1/4 second, then displayed.
- "OFF" means that the channel's display will update as quickly as possible.

14.4.6 POWER-ON SOURCE Menu Item

This menu selects which value is displayed by the channel when first entering the RUN mode.

For single-line displays, the choices are:

- "TRACK" means the live tracking value of the channel.
- "PEAK" means the highest value of the channel.
- "VALLEY" means the lowest value of the channel.

For multi-line displays, the choices are:

- "TRACK" means the live tracking value of the channel.
- "PEAK" means the highest value of the channel.
- "VALLEY" means the lowest value of the channel.
- "TRACK / PEAK" means the live tracking value and the highest value of the channel.
- "TRACK / VALLEY" means the live tracking value and the lowest value of the channel.
- "PEAK / VALLEY" means the highest and lowest values of the channel.

14.5 Troubleshooting

See “Error Messages” on page 127 for information relating to error messages.

NOTICE

Supplemental Instructions included with the instrument may contain important information about which indicator lights, Function Input pins and/or Limit Output pins of the System connector are used by the Mathematics Virtual channel.

15.1 Overview

If the instrument detects an error during the RUN, INITIALIZE, or SETUP modes, it stops operation and enters its ERROR mode as described in “Operating Modes” on page 19.

The most frequent causes of error messages are:

- Wiring/electrical connection problems
- Misplaced address jumpers when installing or removing channel circuit boards
- Swapping channel circuit boards between instruments
- Incorrect calibration of the transducer to the instrument

15.2 Error Message List

Error 05, DIVIDE BY ZERO	A Mathematics Virtual channel has attempted to divide by zero.
Error 07, SQUARE ROOT	A Mathematics Virtual channel has attempted to take the square root of a negative number.
Error 09, LOG/LN	A Mathematics Virtual channel has attempted to take the logarithm of either zero or a negative number.
Error 16, +15V SUPPLY HIGH	The internal +15 VDC power supply is generating a voltage that is too high.
Error 17, +15V SUPPLY LOW	The internal +15 VDC power supply is generating a voltage that is too low. Check the wiring between the instrument and the transducer or amplifier.
Error 18, -15V SUPPLY HIGH	The internal -15 VDC power supply is generating a voltage that is too high (more positive). Check the wiring between the instrument and the transducer or amplifier.
Error 19, -15V SUPPLY LOW	The internal -15 VDC power supply is generating a voltage that is too low (more negative).
Error 20, CHANNEL >MAXCH	An invalid channel number has been encountered by the instrument. Restart the instrument. If this error persists, contact our Service department with the information found in the <code>SYSTEM MENU -> SOFTWARE REV.</code> menu item.
Error 21, BLOWN STACK	The instrument's software stack has overflowed. Restart the instrument. If this error persists, contact our Service department with the information found in the <code>SYSTEM MENU -> SOFTWARE REV.</code> menu item.
Error 22, TYPE NOT FOUND	The instrument has not been programmed to understand the type of channel. Contact our Service department with the information found in the <code>SYSTEM MENU -> SOFTWARE REV.</code> menu item.
Error 23, CAN'T RENDER FS	The full-scale value of the transducer cannot be rendered on the display with the selected <code>DISPLAY SETUP</code> menu settings. Change the <code>DISPLAY SETUP</code> menu settings to better match the transducer's capacity.
Error 24, SIG. MOD CRC ROM	A checksum error occurred while reading a <i>Signature Module's</i> read-only-memory. Check the wiring and restart the instrument. This error may occur with very long cable lengths.
Error 25, SIG. MOD CRC READ	A checksum failure occurred reading data from a Signature Module. Check the wiring. This error may be caused by a faulty <i>Signature Module</i> .
Error 26, NO SIG. MOD.	No <i>Signature Module</i> was detected during <code>UPDATE SIG. MOD.</code> or <code>DEFAULT SIG. MOD.</code> Check wiring.
Error 27, S.EE WRITE NAK	The channel's EEPROM could not be detected during a write operation. Restart the instrument.
Error 28, S.EE READ NAK	The channel's EEPROM could not be detected during a read operation. Restart the instrument.
Error 29, S.EE VERIFY FAIL	A verification failure occurred during a write operation to the channel's EEPROM.

	Restart the instrument.
Error 30, S. EE ERASE NAK	The channel's EEPROM could not be detected during an erase operation. Restart the instrument.
Error 31, BLANK IDENT	The channel does not appear to have been installed properly. This occurs if you swap Input or Output boards without using <code>SYSTEM MENU -> INSTALL CHANNEL</code> to format the channel's EEPROM.
Error 32, BOGUS EE ADDR	An invalid address has been passed to the programmer. Restart the instrument. If this problem persists, contact our Service department with the information found in the <code>SYSTEM MENU -> SOFTWARE REV.</code> menu item.
Error 33, SIG. MOD WIRES	The instrument has detected that the (+)Signature and (-)Signature pins (labeled as "+MEM" and "-MEM") are likely reversed.
Error 34, SIG. MOD MISMATCH	The excitation type byte found inside a <i>Signature Module</i> indicates that the channel is not designed to operate with that type of transducer.
Error 35, BOGUS MENU TYPE	A menu contains an invalid menu type. Contact Sensotec with the information found in the <code>SYSTEM MENU -> SOFTWARE REV.</code> menu item.
Error 36, BAD EE TABLE	The instrument doesn't understand the EEPROM type setting for the channel. Contact Sensotec with the information found in the <code>SYSTEM MENU -> SOFTWARE REV.</code> menu item.
Error 37, BAD PERSONALITY	The channel doesn't understand the given card type. Contact Sensotec with the information found in the <code>SYSTEM MENU -> SOFTWARE REV.</code> menu item.
Error 38, BAD FORMAT	The channel's EEPROM memory contains a display setting which is not understood by the instrument. Check that every item in the channel's <code>DISPLAY SETUP</code> menu has a valid setting.
Error 39, WRONG HARDWARE	The channel type expected by the instrument for the channel number is not the channel type that is physically installed. If you have changed the address jumpers on one or more channels, replace them in their original configuration.
Error 41, SHUNT CAL ERROR	<p>The application of the shunt resistor did not affect the transducer's output. Check the wiring and the transducer output with a voltmeter to verify proper operation.</p> <p>If this error occurs on a Strain-Gage Channel:</p> <ul style="list-style-type: none"> • Verify that the shunt calibration resistor installed on the Main Circuit Board is the correct value per the transducer's Calibration Record. • Most unamplified strain-gage transducers do not include a "buffered shunt cal" feature. Verify that jumper settings are correct according to Table 4-8, "Shunt Cal Application Configuration," on page 54. <p>If this error occurs on a High-Level Input Channel, make certain that the Shunt 1 and Shunt 2 pins are connected to the correct pins of the transducer/amplifier.</p>
Error 43, BAD IDENT CRC	A checksum failure has occurred when reading a channel's EEPROM. Restart the instrument.
Error 44, BAD FUNCTION	The instrument has requested that the channel perform a function that it is not capable of. Restart the instrument.

Error 45, A/D NAK	Hardware error. The channel's Analog-to-Digital converter is not communicating with the channel's microprocessor. Restart the instrument.
Error 46, SENSE WIRES	The amplifier circuit's self test has failed. Restart the instrument.
Error 47, BAD EE TYPE REQ	When installing a channel, the EEPROM type requested by the channel is not valid. Contact Sensotec with the information found in the <code>SYSTEM MENU -> SOFTWARE REV.</code> menu item.
Error 48, NULL MENU	A menu contains a NULL item. Contact our Service department with the information found in the <code>SYSTEM MENU -> SOFTWARE REV.</code> menu item.
Error 49, NULL ACTION FCN	A menu contains a NULL action function. Contact our Service department with the information found in the <code>SYSTEM MENU -> SOFTWARE REV.</code> menu item.
Error 50, EXCITATION	The channel's excitation voltage regulator has shut down because the protection circuit that limits the output current has activated. This is most likely caused by a short of the (+)Excitation and (-)Excitation pins (labeled as "+EXC" and "-EXC").
Error 51, CAN'T DO EXC.	The channel's EEPROM memory contains an excitation setting which is not understood by the instrument. Change the channel's <code>CALIBRATION DATA -> EXCITATION</code> menu item to another setting.
Error 52, SIG. MOD LENGTH R	An unexpected length byte was found inside a <i>Signature Module</i> during a read operation. Check the wiring.
Error 53, SIG. MOD RECTYPE	An unexpected record type was found inside a <i>Signature Module</i> during a read operation. Check the wiring.
Error 54, SIG. MOD LENGTH W	An unexpected record type was found inside a <i>Signature Module</i> during a write operation. Check the wiring and re-start the instrument.
Error 55, SIG. MOD VERIFY SP	A data verification error occurred during a write operation to a <i>Signature Module's</i> scratchpad. Check the wiring and re-start the instrument.
Error 56, SIG. MOD VERIFY	A data verification error occurred during a write operation to a <i>Signature Module</i> . Check the wiring and re-start the instrument.
Error 57, WRONG SIG. MOD.	You have attempted to perform an <code>UPDATE SIG. MOD.</code> operation with a different <i>Signature Module</i> than what was connected when the instrument was powered up. Re-connect the original transducer/ <i>Signature Module</i> and restart the instrument. Another cause of this error is described in the description for Error 68 below.
Error 58, WRONG EE VERSION	The channel's EEPROM memory data is not able to be used by this version of firmware. Make certain that you have not accidentally swapped channel circuit boards between instruments. If you are certain that you want to use the channel circuit board with this instrument, you may reset the channel's EEPROM memory data to factory defaults with the <code>SYSTEM MENU -> DEFAULT CHANNEL</code> menu item.
Error 59, CAN'T DO SIG. MOD	A <i>Signature Module</i> is connected to a channel which doesn't support <i>Signature Calibration</i> . Only Strain Gage Input channels are designed to operate with <i>Signature Calibration</i> .
Error 60, SLAVE TIMEOUT	The channel's microprocessor did not respond because the channel's analog-to-digital converter did not calibrate properly. Restart the instrument.

Error 61, LOAD NOT GT LOAD	<p>A load applied during a known-load calibration was not greater than a previously applied load. To insure both correct operation of the transducer and application of the load, the instrument expects the voltage applied at each known-load point to be increasing. For example, the load applied at Known-Load Point 2/2 must cause the transducer to produce a more positive voltage than at Known-Load Point 1/2.</p> <p>If you are calibrating with a AC-AC LVDT Input channel, make certain that you have followed the procedure described in “Electrical Null and Transducer Mounting” on page 87.</p>
Error 62, SLAVE NAK	<p>The channel's microprocessor is responding to a message, but it did not acknowledge it correctly. Restart the instrument.</p>
Error 67, LOADS NOT CLOSE	<p>During a 5-Point Known-Load calibration, you would typically apply loads at 0%, 25%, 50%, 75% and 100% of the transducer's full-scale and optionally calibrate the return points of 75%, 50%, 25% and 0%. The instrument makes sure that transducer readings taken during the second application of the load are close to the readings taken during the first application of the load. This insures both correct operation of the transducer and application of the loads.</p>
Error 68, CAN'T CALIBRATE	<p>The instrument has detected that the transducer presently connected to the channel is different than the transducer the channel was last calibrated with. Ordinarily, the instrument would perform a Shunt Calibration or mV/V Calibration. However, since the channel's CALIBRATION TYPE menu item is set to one of the Known-Load Calibration settings, no calibration can take place. Either re-connect the original transducer, use the SETUP menu to perform a calibration or use the SETUP menu to change the calibration type.</p>
Error 70, CAN'T DO GAIN	<p>The channel's EEPROM memory contains an input range setting which is beyond the capabilities of the channel. Change the channel's CALIBRATION DATA -> FULL SCALE MV/V menu item to another setting.</p>
Error 71, SLAVE CHECKSUM	<p>The channel's microprocessor did not send a correct checksum to the instrument. Restart the instrument.</p>
Error 72, CAN'T DO FILTER	<p>The channel's EEPROM memory contains a frequency response setting which is not understood by the instrument. Change the channel's OPERATION -> FREQ. RESPONSE menu item to another setting.</p>
Error 73, SLAVE NOT INIT	<p>The channel's microprocessor has not yet been initialized by the instrument. Restart the instrument.</p>
Error 74, SLAVE BAD REPLY	<p>The channel's microprocessor replied with a message that was either not understood or different than expected. Restart the instrument.</p>
Error 75, SLAVE NOT FOUND	<p>The channel's microprocessor did not respond. Restart the instrument.</p>
Error 76, A/D ZERO CHECK	<p>The amplifier circuit's self test has failed. Check the wiring and re-start the instrument.</p>
Error 77, A/D SPAN CHECK	<p>The setting of Jumper J23 on the Main Circuit Board (see Figure 10-4, “Location of Shunt Cal Application Jumpers,” on page 54) is incorrect. This jumper should be installed on Strain-Gage Input channels when the setting of the FULL SCALE MV/V menu item is less than 5.5 mV/V. Otherwise, this jumper should be removed.</p>
Error 81, OPERAND EXPECTED	<p>The first step of a SensoCode program must be an Operand. The SensoCode program loaded in the Mathematics Virtual channel is invalid.</p>

Error 82, BAD OPERAND	The SensoCode program loaded into a Mathematics Virtual channel contains a bad operand.
Error 83, BAD INSTRUCTION	The SensoCode program loaded into a Mathematics Virtual channel contains a bad instruction.
Error 84, BAD VALUE	A Mathematics Virtual channel has attempted to get a value from a channel not installed in the instrument.
Error 85, UNREACHABLE GOTO	The destination step of a "Go to" Instruction is beyond the end of the SensoCode program. The SensoCode program loaded in the Mathematics Virtual channel is invalid.
Error 87, GOTO NOT JUMP	The SensoCode program contains a "Go to" Instruction that has not been converted into a "Jump" Instruction. Restart the instrument.

16.1 Navigation instructions

- Press [UP]+[DOWN] to enter the SETUP menu mode.
- Press [UP] to move up.
- Press [DOWN] to move down.
- Press [ENTER] to select an item.
- Press [EXIT] to re-start the instrument.

Table 5-13: SETUP Menu

CHANNEL 01 MENU	——	(menu varies according to channel type)
CHANNEL 02 MENU	——	(menu varies according to channel type)
CHANNEL 03 MENU	——	(menu varies according to channel type)
CHANNEL 04 MENU	——	(menu varies according to channel type)
LIMIT 01 MENU	——	(optional)(see LIMIT MENU)
LIMIT 02 MENU	——	(optional)(see LIMIT MENU)
LIMIT 03 MENU	——	(optional)(see LIMIT MENU)
SYSTEM MENU	——	(see SYSTEM MENU)
SERIAL COM MENU	——	(see SERIAL COM MENU)
DISPLAY MENU	——	(see DISPLAY MENU)

Table 5-14: System Menu

SYSTEM MENU	SOFTWARE REVISION			page 35
	CONFIGURATION	<ul style="list-style-type: none"> — DISPLAY TYPE — CHANNEL 01 TYPE — CHANNEL 02 TYPE — CHANNEL 03 TYPE — CHANNEL 04 TYPE — CHANNEL 05 TYPE — CHANNEL 06 TYPE — CHANNEL 07 TYPE — CHANNEL 08 TYPE — CHANNEL 09 TYPE — CHANNEL 10 TYPE — CHANNEL 11 TYPE — CHANNEL 12 TYPE — CHANNEL 13 TYPE — CHANNEL 14 TYPE — CHANNEL 15 TYPE — CHANNEL 16 TYPE — CHANNEL 17 TYPE — CHANNEL 18 TYPE — CHANNEL 19 TYPE — CHANNEL 20 TYPE — CHANNEL 21 TYPE — CHANNEL 22 TYPE — CHANNEL 23 TYPE — LEAVE SUB-MENU 		page 35
	DIAGNOSTICS	<ul style="list-style-type: none"> — LIMIT OUTPUT 1 — LIMIT OUTPUT 2 — AUX INPUT TEST — SCAN TIME — LEAVE SUB-MENU 	<ul style="list-style-type: none"> — ON — OFF — ON — OFF 	page 35
	INSTALL CHANNEL	<ul style="list-style-type: none"> — 65 STRAIN GAGE V — 67 HIGH-LEVEL V — 68 LVDT V OUT — AB SPLIT DISPLAY — AE MATHEMATICS 		page 35 page 35 page 36
	DELETE CHANNEL			page 37
	LEAVE MENU			

Table 5-15: LIMIT MENU

LIMIT xx MENU	LIMIT. ENABLE	ON OFF	page 47
	LIMIT. SETPOINT		page 47
	LIMIT. RETURN PNT		page 47
	LIMIT. ENERGIZE	SIGNAL>SETPOINT SIGNAL<SETPOINT SIGNAL INSIDE SIGNAL OUTSIDE	page 47
	LIMIT. LATCHING	ON OFF	page 49
	LIMIT. CHANNEL		page 49
	LIMIT. SOURCE	TRACK PEAK VALLEY	page 49
	LEAVE MENU		

Table 5-16: SERIAL COMMUNICATIONS Menu

SERIAL COM MENU	INTERFACE	page 41
	ADDRESS	page 41
	BAUD RATE	page 41
	AUTO LINE-FEED	page 41
	TRANSMIT TEST	page 41
	LEAVE MENU	

Table 5-17: DISPLAY Menu for Model SC500

DISPLAY MENU	UPPER CHANNEL	page 43	
	LOWER CHANNEL	page 43	
	DISPLAY MODE	LOWER=BLANK LOWER=LIMITS LOWER=CHANNEL UPPER=LARGE	page 43
	LEAVE MENU		

Table 5-18: Strain Gage Input Channel Menu

CHANNEL xx MENU	OPERATION	AUTO-ZERO	ON	page 57
			OFF	
		FREQ. RESPONSE	002. HERTZ/FAST	page 57
			002. HERTZ	
			008. HERTZ	
			016. HERTZ	
			032. HERTZ	
			050. HERTZ	
			100. HERTZ	
			250. HERTZ	
		500. HERTZ		
		800. HERTZ		
		POWER-ON SOURCE	TRACK	page 57
			PEAK	
			VALLEY	
	DISPLAY SETUP	LEAVE SUB-MENU		
		DISPLAY. DIGITS	5 DIGIT-BIPOLAR	page 58
			6 DIGIT-UNIPOLAR	
			7 DIGIT-UNIPOLAR	
		DISPLAY. DECP	99999.	page 58
			9999.9	
			999.99	
			99.999	
			9.9999	
			.99999	
	DISPLAY. COUNTRY	00001	page 58	
		00002		
		00005		
	00010			
	00020			
	00050			
	00100			
	00200			
	DISPLAY. UNITS		page 58	
	DISPLAY. AVERAGE	ON	page 58	
		OFF		
AUX1 FUNCTION	LEAVE SUB-MENU			
	DISABLED		page 51	
	TRACK HOLD			
	HIGH/LOW HOLD			
	HIGH/LOW CLEAR			
	TARE ON			
AUX2 FUNCTION	TARE OFF			
	DISABLED		page 51	
	TRACK HOLD			
	HIGH/LOW HOLD			
	HIGH/LOW CLEAR			
	TARE ON			
CALIBRATION TYPE	TARE OFF			
	TYPE=SHUNT CAL		page 60	
	TYPE=MV/V CAL			

Table 5-18: Strain Gage Input Channel Menu (Continued)

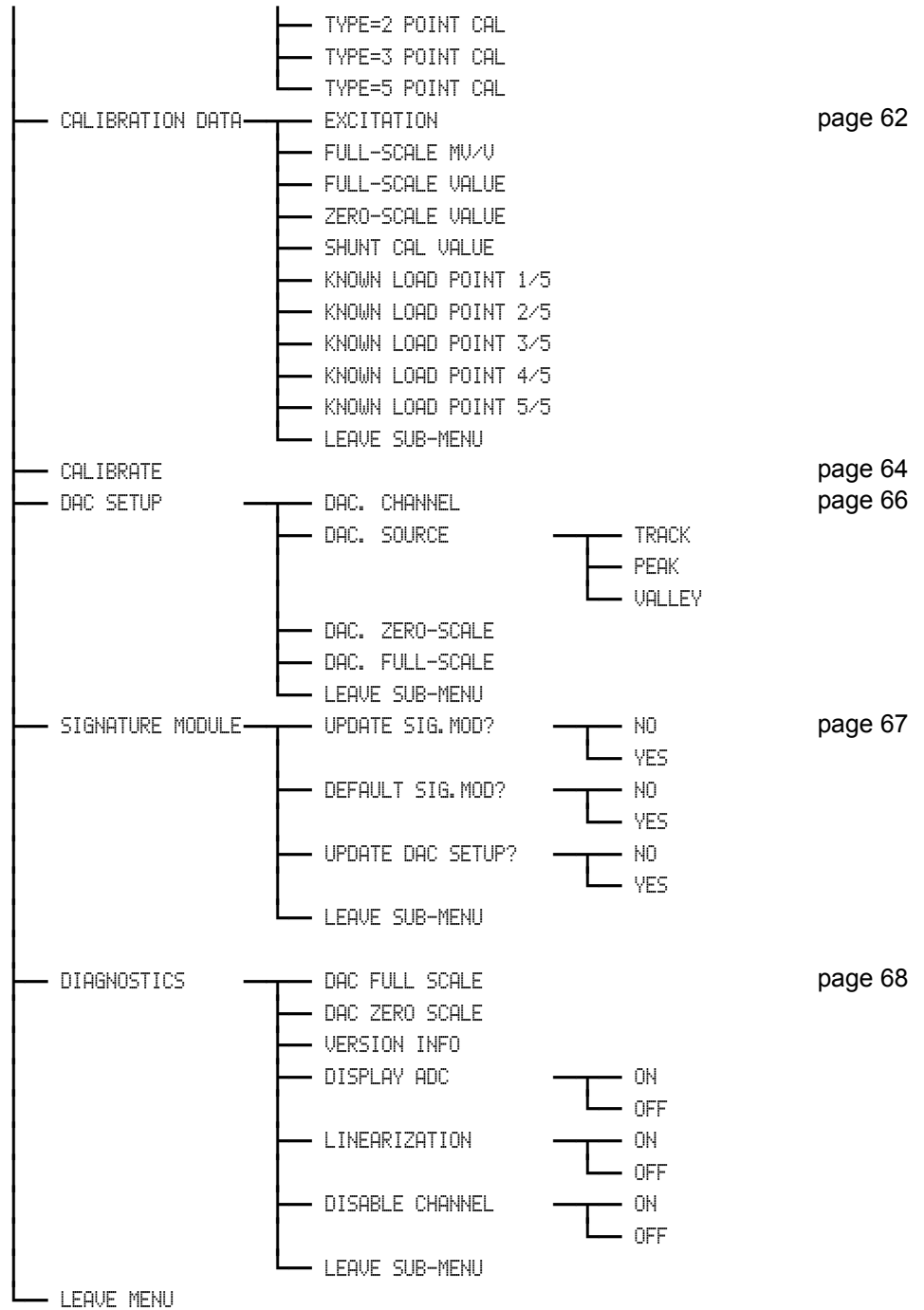

Table 5-19: AC-AC LVDT Input Channel Menu

CHANNEL xx MENU	OPERATION	AUTO-ZERO	ON	page 77
			OFF	
		FREQ. RESPONSE	002. HERTZ/FAST	page 77
			002. HERTZ	
			008. HERTZ	
			016. HERTZ	
			032. HERTZ	
			050. HERTZ	
			100. HERTZ	
			250. HERTZ	
		500. HERTZ		
		800. HERTZ		
		POWER-ON SOURCE	TRACK	page 77
			PEAK	
			VALLEY	
	DISPLAY SETUP	LEAVE SUB-MENU		
		DISPLAY. DIGITS	5 DIGIT-BIPOLAR	page 78
			6 DIGIT-UNIPOLAR	
			7 DIGIT-UNIPOLAR	
		DISPLAY. DECP	99999.	page 78
			9999.9	
			999.99	
			99.999	
			9.9999	
			.99999	
	DISPLAY. COUNTRY	00001	page 78	
		00002		
		00005		
	00010			
	00020			
	00050			
	00100			
	00200			
	DISPLAY. UNITS		page 78	
	DISPLAY. AVERAGE	ON	page 78	
		OFF		
AUX1 FUNCTION	LEAVE SUB-MENU			
	DISABLED		page 78	
	TRACK HOLD			
	HIGH/LOW HOLD			
	HIGH/LOW CLEAR			
	TARE ON			
TARE OFF				
AUX2 FUNCTION	DISABLED		page 78	
	TRACK HOLD			
	HIGH/LOW HOLD			
	HIGH/LOW CLEAR			
	TARE ON			
	TARE OFF			
CALIBRATION TYPE	TYPE=2 POINT CAL		page 80	
	TYPE=3 POINT CAL			

Table 5-19: AC-AC LVDT Input Channel Menu (Continued)

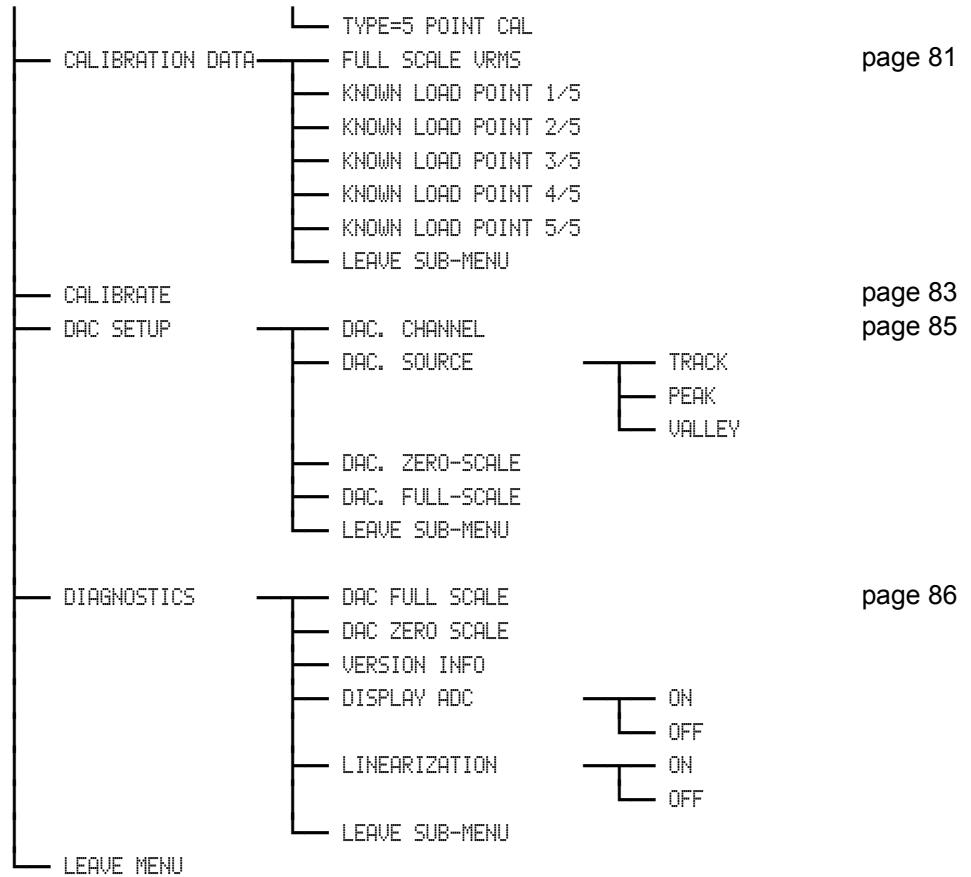

Table 5-20: High-Level Input Channel Menu

CHANNEL xx MENU	OPERATION	AUTO-ZERO	ON	page 103
			OFF	
		FREQ. RESPONSE	002. HERTZ/FAST	page 103
			002. HERTZ	
			008. HERTZ	
			016. HERTZ	
			032. HERTZ	
			050. HERTZ	
			100. HERTZ	
			250. HERTZ	
		500. HERTZ		
		800. HERTZ		
		POWER-ON SOURCE	TRACK	page 103
			PEAK	
			VALLEY	
	DISPLAY SETUP	LEAVE SUB-MENU		
		DISPLAY. DIGITS	5 DIGIT-BIPOLAR	page 104
			6 DIGIT-UNIPOLAR	
			7 DIGIT-UNIPOLAR	
		DISPLAY. DECP	99999.	page 104
			9999.9	
			999.99	
			99.999	
			9.9999	
			.99999	
	DISPLAY. COUNTRY	00001	page 104	
		00002		
		00005		
	00010			
	00020			
	00050			
	00100			
	00200			
DISPLAY. UNITS		page 104		
DISPLAY. AVERAGE	ON	page 104		
	OFF			
LEAVE SUB-MENU				
AUX1 FUNCTION	DISABLED	page 105		
	TRACK HOLD			
	HIGH/LOW HOLD			
	HIGH/LOW CLEAR			
	TARE ON			
	TARE OFF			
AUX2 FUNCTION	DISABLED	page 105		
	TRACK HOLD			
	HIGH/LOW HOLD			
	HIGH/LOW CLEAR			
	TARE ON			
	TARE OFF			
CALIBRATION TYPE	TYPE=SHUNT CAL	page 106		
	TYPE=2 POINT CAL			

Table 5-20: High-Level Input Channel Menu (Continued)

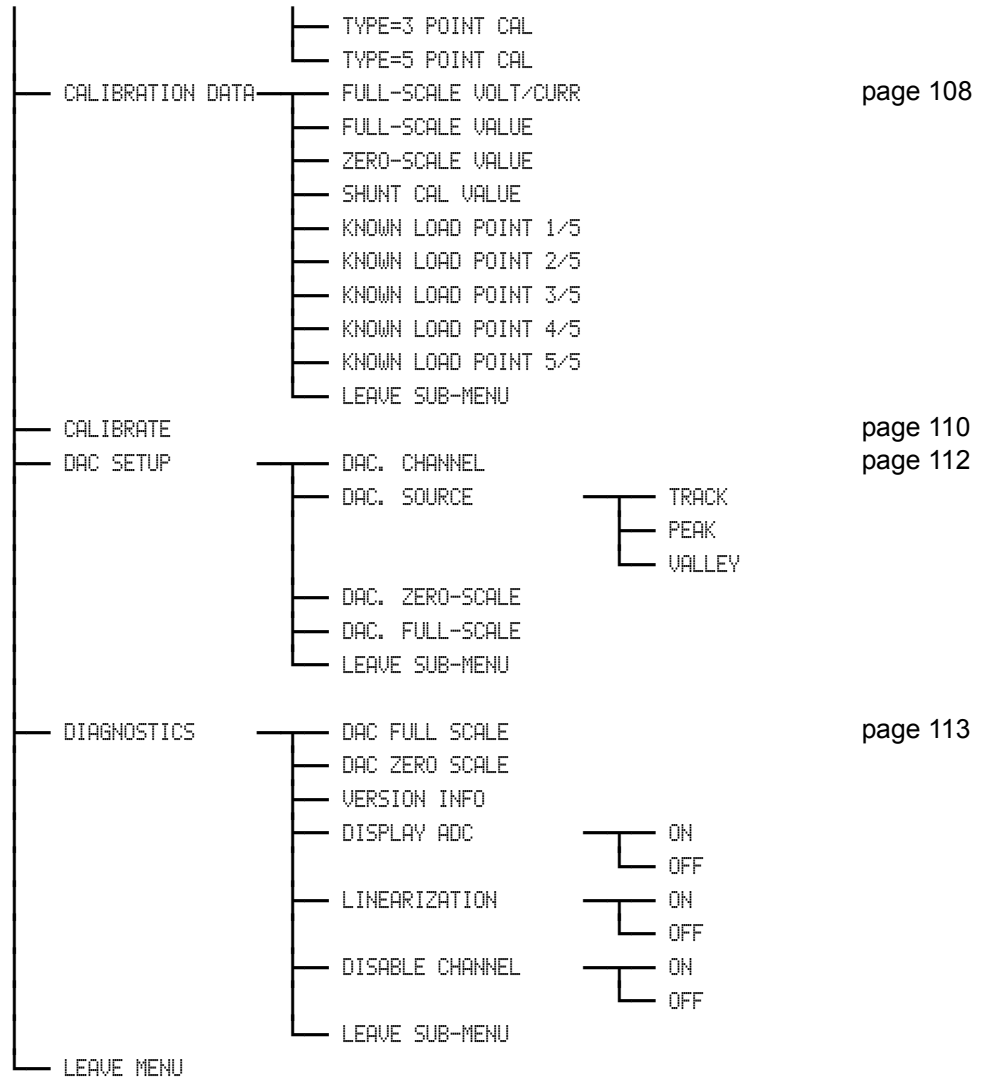
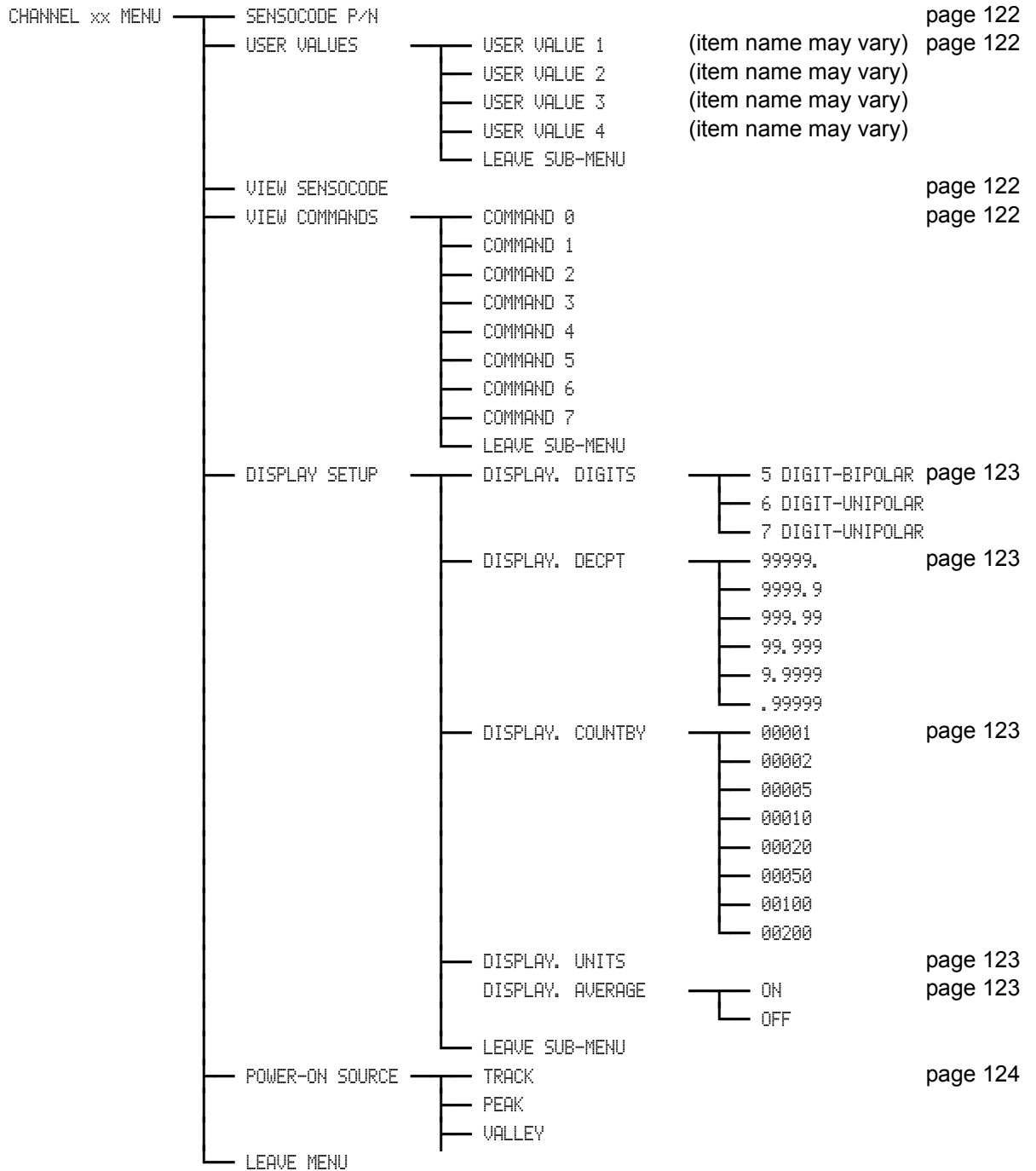

Table 5-21: Split Display Virtual Channel

CHANNEL xx MENU	LEFT CHANNEL		page 118
	LEFT SOURCE	TRACK	page 118
		PEAK	
		VALLEY	
	RIGHT CHANNEL		page 118
	RIGHT SOURCE	TRACK	page 118
		PEAK	
		VALLEY	
	LEAVE MENU		

Table 5-22: Mathematics Virtual Channel



A

- AC/AC-LVDT Input channel 73
 - 2-Point Known Displacement Calibration 80–81, 83
 - 3-Point Known Displacement Calibration 80–81, 83
 - 5-Point Known Displacement Calibration 80–81, 83
 - auto-zero function 77
 - Auxilliary Function pins 78, 89
 - calibration procedure 75
 - calibration types comparison 80
 - Digital-to-Analog Output 74, 85–86, 88–89
 - display setup 78
 - electrical null 87
 - EMI/RFI interference 89
 - frequency response 77
 - OULD message 89
 - remote control of Track/Hold, Peak/Valley clear, Peak/Valley hold or Tare 78, 89
 - resolution 77
 - SETUP menu 77
 - software revision 86
 - specifications 76
 - step-response time 77
 - transducer mounting 87
 - troubleshooting 89
 - wiring 74
- analog output. See Digital-to-Analog Output
- auto-zero function
 - AC/AC-LVDT Input channel 77
 - High-Level Input channel 103
 - Strain-Gage Input channel 57
- Auxilliary Function pins
 - AC/AC-LVDT Input channel 78, 89
 - High-Level Input channel 105, 115
 - Strain-Gage Input channel 58, 70

B

- buttons
 - CHANNEL 20
 - CLEAR 20, 49
 - DOWN 23
 - ENTER 23
 - EXIT 23
 - TARE 21
 - UP 23
 - VALUE 20

C

- calibration
 - AC/AC-LVDT Input channel 75
 - High-Level Input channel 101
 - Strain-Gage Input channel 55

- case removal
 - of SC500 29
- channel
 - changing which is displayed 20, 43
 - clearing peak and valley 20
 - deleting last in instrument 37
 - Input 12
 - installation 36
 - list of all in instrument 35
 - reset to default settings 37
 - types 12
 - Virtual 12
- CHANNEL button 20
- Chassis 25
- cleaning 30
- CLEAR button 20, 49
- Communications Guide 11, 39
- connectors
 - Options 32
- Customer Information Sheet 11

D

- Digital-to-Analog Output
 - AC/AC-LVDT Input channel 74, 85–86, 88–89
 - High-Level Input channel 92, 112–115
 - Strain-Gage Input channel 52, 66–70
- display
 - averaging
 - AC/AC-LVDT Input channel 78
 - High-Level Input channel 104
 - Mathematics Virtual channel 123
 - Strain-Gage Input channel 58
 - changing channel shown on 20, 43
 - changing character size of 43
 - decimal points
 - AC/AC-LVDT Input channel 78
 - High-Level Input channel 104
 - Mathematics Virtual channel 123
 - Strain-Gage Input channel 58
 - lower line 20, 43
 - mode 43
 - OULD message
 - AC/AC-LVDT Input channel 89
 - High-Level Input channel 115
 - Strain-Gage Input channel 70
 - percentage of Analog-to-Digital converter input 20
 - symbols 20
 - track, peak or valley 20
 - units of measure
 - AC/AC-LVDT Input channel 78
 - High-Level Input channel 104
 - Mathematics Virtual channel 123
 - Strain-Gage Input channel 58

when shunt calibration resistor applied 21
DOWN button 23

E

EMI/RFI interference
 AC/AC-LVDT Input channel 89
 High-Level Input channel 115
 Strain-Gage Input channel 71
ENTER button 23
error messages 127
ERROR mode 22
excitation
 Strain-Gage Input channel 62
EXIT button 23

F

frequency response
 AC/AC-LVDT Input channel 77
 High-Level Input channel 103
 Strain-Gage Input channel 57

H

High-Level Input channel 91
 2-Point Known Load Calibration 106, 108, 110
 3-Point Known Load Calibration 106, 108, 110
 5-Point Known Load Calibration 106–107, 109, 111
 auto-zero function 103
 Auxilliary Function pins 105, 115
 calibration procedure 101
 calibration types comparison 106
 Digital-to-Analog Output 92, 112–115
 display setup 104
 EMI/RFI interference 115
 frequency response 103
 OVL message 115
 remote control of Track/Hold, Peak/Valley clear,
 Peak/Valley hold or Tare 105, 115
 resolution 103
 SETUP menu 103
 Shunt Calibration 21, 106, 108, 110
 software revision 113
 specifications 102
 step-response time 103
 troubleshooting 115
 wiring 92

I

indicator lights
 limits 46
 lower line display of 43
 Tare 21
INITIALIZE mode 19
installation of channels 36

L

LEDs. See indicator lights.
lights. See indicator lights.
limits
 clearing latched limits 20
 enabling 47
 indicator lights
 latching 49
 operation 46–47, 49
 Relay outputs 34, 46
 scan time 46
 SETUP menu 47
 wiring 32
LVDT Input channel
 See AC/AC-LVDT Input channel

M

Mathematics Virtual channel 119
 display setup 123
 operation 121
 SensoCode 119
 part number 122
 viewing program 122
 SETUP menu 122
 troubleshooting 125
 user values 122
 wiring 120
menu. See SETUP menu mode.

O

operating modes 19
 ERROR 22
 INITIALIZE 19
 RUN 20
 SETUP menu 23
Options Connector
 wiring 32
OVL message
 AC/AC-LVDT Input channel 89
 High-Level Input channel 115
 Strain-Gage Input channel 70

P

panel mounting
 of SC500 27
Peak/Valley values
 AC/AC-LVDT Input channel 77
 displaying 20
 High-Level Input channel 103
 Strain-Gage Input channel 57
power adapter, wall mount AC 30
power connector 30

Q

quick start 15

R

rack mounting
 of SC500 28
remote control. See Auxilliary Function pins 58, 78, 105
resolution
 AC/AC-LVDT Input channel 77
 High-Level Input channel 103
 Strain-Gage Input channel 57
RS-232
 wiring 32
RS-232. See Serial Communications
RS-485
 wiring 32
RS-485. See Serial Communications
RUN mode 20

S

SC Series
 features 12
SC500 27
SensoCode 119
 part number 122
 software revision 122
 viewing 122
Serial Communications 39
 communications parameters 40–41
 RS-232 defined 40
 RS-485 defined 40
Serial Communications Guide 11
SETUP menu mode
 navigation instructions 133
 overview 23
 reference 134
shunt calibration check 21
Signature Calibration
 defined 13
 with Strain-Gage Input channel 60, 67
Signature Module 67
 defaulting to factory settings 67
 updating channel's Digital-to-Analog Output settings
 67
 writing with information from SETUP menus 67
software revision
 AC/AC-LVDT Input channel 86
 chassis 35
 High-Level Input channel 113
 Mathematics Virtual channel 122
 SensoCode program 122
 Strain-Gage Input channel 68
specifications
 AC/AC-LVDT Input channel 76
 Chassis Models 26

 High-Level Input channel 102
 Strain-Gage Input channel 56
Split Display Virtual channel 117
 display formatting 117
 SETUP menu 118
step-response time
 AC/AC-LVDT Input channel 77
 High-Level Input channel 103
 Strain-Gage Input channel 57
Strain-Gage Input channel
 2-Point Known Load Calibration 60–62, 64
 3-Point Known Load Calibration 60–61, 63–64
 5-Point Known Load Calibration 60–61, 63, 65
 auto-zero function 57
 Auxilliary Function pins 58, 70
 calibration procedure 55
 calibration types comparison 60
 Digital-to-Analog Output 52, 66–70
 display setup 58
 EMI/RFI interference 71
 excitation 62
 frequency response 57
 mV/V Calibration 60–61, 64
 OVL message 70
 remote control of Track/Hold, Peak/Valley clear,
 Peak/Valley hold or Tare 58, 70
 resolution 57
 SETUP menu 57
 Shunt Calibration 21, 60, 62, 64
 software revision 68
 specifications 56
 step-response time 57
 troubleshooting 70
 wiring 52
System Connector
 diagnostics 35

T

Tare
 activating or deactivating 21
 See also Auxilliary Function pins.
Tare light 21
troubleshooting
 AC/AC-LVDT Input channel 89
 High-Level Input channel 115
 Strain-Gage Input channel 70

U

UP button 23
user values 122

V

VALUE button 20

W

wiring

AC/AC-LVDT Input channel 74

High-Level Input channel 92
Mathematics Virtual channel 120
Strain-Gage Input channel 52

Warranty

Honeywell warrants goods of its manufacture as being free of defective materials and faulty workmanship. Contact your local sales office for warranty information. If warranted goods are returned to Honeywell during the period of coverage, Honeywell will repair or replace without charge those items it finds defective. The foregoing is the Buyer's sole remedy and is in lieu of all other warranties, expressed or implied, including those of merchantability and fitness for a particular purpose.

Specifications may change without notice. The information we supply is believed to be accurate and reliable as of this printing. However, we assume no responsibility for its use.

While we provide applications assistance personally, through our literature and the Honeywell web site, it is up to the customer to determine the suitability of the product in the application.

Honeywell

Honeywell Automation and Control Solutions

Sensotec Sensors
2080 Arlingate Lane
Columbus, Ohio 43228-4112
Tel: (614)850-5000
Fax: (614)850-1111
E-mail: service@sensotec.com

<http://www.honeywell.com/sensotec>