

## COMPACT HORIZONTAL LIMIT SWITCHES (RUGGED) Model SL1-□C

- The C-spring material is a high-cobalt alloy, which enhances resistance to coolants.
- The shape of the diaphragm seal has been modified to prevent cracking and degradation of insulation (standard type).
- The internal plunger with a molded-in diaphragm seal prevents coolant from entering inside.
- This series offers potted switches that protect the conduit and terminals.

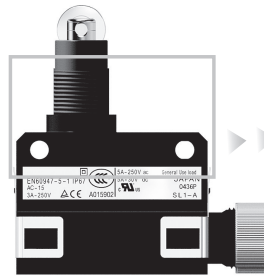

The structure of the molded-in seal (Internal Plunger / Diaphragm seal) does not crack easily when the product slides. It also keeps the coolant completely out.

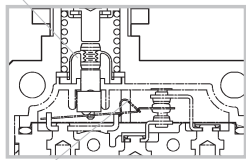

The C-spring (made of a high-cobalt alloy) does not degrade due to corrosion.

### PERFORMANCE

	Item	Details	
<b>Standards</b>	<b>Compliance</b>	NECA C 4508/JIS C 8201-5-1/IEC 60947-5-1	
	<b>Certification</b>	UL 508/CSA C22.2 No. 14 (C-UL)/EN 60947-5-1/GB14048.5 (except Models with a DIN connector)	
<b>Structure</b>	<b>Contact form</b>	Single-Pole Double-Throw (SPDT; refer to contact diagram below)	
	<b>Contact type</b>	Standard load type: pure silver rivet Low current load type: gold-plated rivet	
	<b>Terminal type</b>	M3 screw	
	<b>Protective structure</b>	IP67 (IEC 60529, JIS C 0920)	
	<b>Pollution level</b>	3 (EN 60947-5-1)	
	<b>Electrical performance</b>	<b>Electrical rating</b>	See Table 1.
<b>Rated frequency</b>		45 to 65 Hz and D.C.	
<b>Insulation resistance</b>		Between non-continuous terminals: 100 MΩ Between each terminal and non-live metal parts: 100 MΩ	
<b>Rated insulation resistance (Ui)</b>		250V Dielectric strength between each terminal and non-conducting metal parts: 2,000 Vac (45 to 65 Hz, 5 s, leak current 1 mA)	
<b>Dielectric strength between contacts</b>		1,000 Vac (50 to 60 Hz, 1 minutes, leak current 1 mA)	
<b>Rated impulse dielectric strength (Uimp)</b>		2,500V	
<b>Switching overcurrent</b>		Category II (IEC 60204-1)	
<b>Initial contact resistance</b>		Silver contacts: 50 mΩ max. (6 to 8 Vdc 1A, voltage drop method) Gold-plated contacts: 100 mΩ max. (6 to 8 Vdc 0.1A, voltage drop method)	
<b>Contact minimum allowable load</b>		Silver contacts: 5 mA 24 Vdc, 10 mA 12 Vdc Gold-plated contacts: 5 mA 5 Vdc	
<b>Rated thermal current (Ith)</b>		Silver contacts: 3A Gold-plated contacts: 1A (Temperature increase: 65°C max.)	
<b>Short-circuit protection</b>		M10A (IEC 60127) (TÜV) Instant blowing fuse, 10A (silver contacts) or 3A (gold contacts) (CQC)	
<b>Conditional rated short-circuit current</b>		1,000A (power factor 0.5 to 0.7)	
<b>Mechanical performance</b>		<b>Actuator strength</b>	Withstands load 5 times O.F. (operating direction for 1 minute)
		<b>Terminal strength</b>	Withstands tightening torque of 0.6 N·m for 1 minute
	<b>Impact resistance (malfunction)</b>	300 m/s <sup>2</sup> , contact opening for 1 ms max. in free position and total travel position (NECA C 4508)	
	<b>Vibration resistance (malfunction)</b>	1.5 mm peak-to-peak amplitude for 2 continuous hours Contact opening for 1 ms max. in free position and total travel position (NECA C 4508)	
	<b>Allowable operating speed</b>	0.02 mm/s to 0.5 m/s. 0.02 mm/s to 0.25 m/s on the Model SL1-B	
	<b>Operating frequency</b>	120 operations/minute. (60 operations/min for high oil type).	

Life	Mechanical	Min. 20 million operations. Min. 2 million operations for the Model <b>SL1-B</b> . Min. 2 million operations for high oil type. (All values assume overtravel (O.T.) of 1/3 to 2/3 the rated amount.)
	Electrical	Standard-load type: Min. 2 million actions (1 A, 125 Vac) Min. 300,000 actions (3 A, 250 Vac; 2 A, 48 V DC; 3 A, 30 Vdc) Minute-load type: Min. 5 million actions (0.1 A, 125 Vac; 0.1 A, 48 Vdc) Min. 2 million actions for the Model SL1-B and the high-temperature-resistant models. Useful life based on oil drip tests (reference specifications) Min. 2 million actions Test conditions Cutting fluid: Yushiroken EC50T-3 (Yushiro Chemical Industries Co., Ltd.) Synthetic #770TG (Yushiro Chemical Industries Co., Ltd) EMALCUT DC-60 (Kyodo Yushi Co., Ltd) Open-close frequency: 60 cycles/minute Standard test conditions • Temperature: +20 °C • Relative humidity: 65 %
Ambient operating conditions	Temperature	Standard type: -10 to +70°C High oil type: 0 to 120°C
	Humidity	Max. 98% RH
Recommended tightening torque	Body	1.3 to 1.7 N·m (M4 hexagon socket head bolt)
	Terminal screw	0.4 to 0.6 N·m (M3 binding head machine screw)
	Panel mounting nut	4 to 6 N·m (M14 hexagonal nut)

● Attached Table 1. Electrical rating

Item	Contact material	Not applicable to models with a DIN connector		Models with a DIN connector
		JIS/IEC/EN/GB	UL/CSA	
Standard load type	Silver rivet	AC-15:3A-250V AC-12:3A-250V DC-12:2A-48V	3A-250 Vac General Use Load 3A-30 Vdc	DC-12 2A-24V
Low current load type	Gold plated rivet	AC-12:0.1A-125V DC-12:0.1A-48V	0.1A-125 Vac General Use Load 0.1A-30 Vdc	DC-12 0.1A-24V

PHOTOELECTRIC SENSORS & SWITCHES

MEASUREMENT SENSORS

PROXIMITY SWITCHES

LIMIT SWITCHES

SAFETY KEY SWITCHES

LIMIT SWITCHES WITH POSITIVE OPENING MECHANISM

GENERAL PURPOSE LIMIT SWITCHES

TECHNICAL GUIDE FOR LIMIT SWITCHES

EXPLOSION-PROOF SWITCHES

TECHNICAL GUIDE FOR EXPLOSION-PROOF SWITCHES

STANDARD  
LS□

SPATTER-GUARDED  
LS□□

1LS-J7□□

1LS-J8□□

1LS□-J401

VCL□□□

SL1□□□

SL1□□C

Connector with cable



See page F-001

## CONTACT FORM

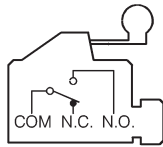

Roller lever type

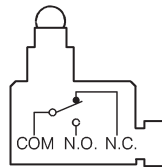
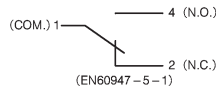

Roller plunger type

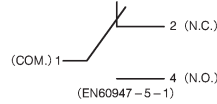

## STANDARDS

	Approving body	Standard	File No.
Certification	UL	UL 508 CSA C22.2 No.14 (C-UL)	E 96090
	TÜV	EN 60947-5-1	R50006349
	CQC	GB 14048.5	2013010305648691

## CONNECTOR PIN LAYOUT

### Wiring diagrams

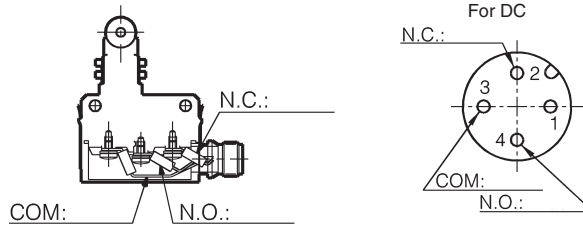







## ORDER GUIDE







### ● Models without a connector

Actuator		Basic catalog listing	Options						
Name	Shape		Standard type without a terminal cover	Minute-load type	Minute-load type without a terminal cover	High-temperature-resistant type	High-temperature-resistant type without a terminal cover	High-temperature-resistant + minute-load type	High-temperature-resistant + minute-load type without a terminal cover
Roller plunger		SL1-AC	SL1-ANC	SL1-AKC	SL1-AKNC	SL1-AVC	SL1-AVNC	SL1-AKVC	SL1-AKVNC
Boot seal roller plunger		SL1-BC	SL1-BNC	SL1-BKC	SL1-BKNC	SL1-BVC	SL1-BVNC	SL1-BKVC	SL1-BKVNC
Cross roller plunger		SL1-DC	SL1-DNC	SL1-DKC	SL1-DKNC	SL1-DVC	SL1-DVNC	SL1-DKVC	SL1-DKVNC
Long roller plunger		SL1-EC	SL1-ENC	SL1-EKC	SL1-EKNC	SL1-EVC	SL1-EVNC	SL1-EKVC	SL1-EKVNC
Plunger		SL1-HC	SL1-HNC	SL1-HKC	SL1-HKNC	SL1-HVC	SL1-HVNC	SL1-HKVC	SL1-HKVNC
Short roller lever		SL1-PC	SL1-PNC	SL1-PKC	SL1-PKNC	SL1-PVC	SL1-PVNC	SL1-PKVC	SL1-PKVNC

● Models with a DIN connector

Actuator		Basic catalog listing	Options		
Name	Shape		Low current load	High temperature	High temperature + low current load
Roller plunger		SL1-AC-PD	SL1-AKC-PD	SL1-AVC-PD	SL1-AKVC-PD
Boot seal roller plunger		SL1-BC-PD	SL1-BKC-PD	SL1-BVC-PD	SL1-BKVC-PD
Cross roller plunger		SL1-DC-PD	SL1-DKC-PD	SL1-DVC-PD	SL1-DKVC-PD
Long roller plunger		SL1-EC-PD	SL1-EKC-PD	SL1-EVC-PD	SL1-EKVC-PD
Plunger		SL1-HC-PD	SL1-HKC-PD	SL1-HVC-PD	SL1-HKVC-PD
Short roller lever		SL1-PC-PD	SL1-PKC-PD	SL1-PVC-PD	SL1-PKVC-PD

● Models with a DIN connector + potting inside the terminal cover

Actuator		Basic catalog listing	Options		
Name	Shape		Low current load	High temperature	High temperature + low current load
Roller plunger		SL1-AC-MD	SL1-AKC-MD	SL1-AVC-MD	SL1-AKVC-MD
Boot seal roller plunger		SL1-BC-MD	SL1-BKC-MD	SL1-BVC-MD	SL1-BKVC-MD
Cross roller plunger		SL1-DC-MD	SL1-DKC-MD	SL1-DVC-MD	SL1-DKVC-MD
Long roller plunger		SL1-EC-MD	SL1-EKC-MD	SL1-EVC-MD	SL1-EKVC-MD
Plunger		SL1-HC-MD	SL1-HKC-MD	SL1-HVC-MD	SL1-HKVC-MD
Short roller lever		SL1-PC-MD	SL1-PKC-MD	SL1-PVC-MD	SL1-PKVC-MD

PHOTOELECTRIC SENSORS & SWITCHES

MEASUREMENT SENSORS

PROXIMITY SWITCHES

LIMIT SWITCHES

SAFETY KEY SWITCHES

LIMIT SWITCHES WITH POSITIVE OPENING MECHANISM

GENERAL PURPOSE LIMIT SWITCHES

TECHNICAL GUIDE FOR LIMIT SWITCHES

EXPLOSION-PROOF SWITCHES

TECHNICAL GUIDE FOR EXPLOSION-PROOF SWITCHES

STANDARD  LS

SPATTER-GUARDED  LS

1LS-J7

1LS-J8

1LS -J401

VCL

SL1

SL1  C

Connector with cable



See page F-001

## PRECAUTIONS FOR USE

### 1. Preparing lead wire tips

Cut and strip the lead wire tip as illustrated below, and use a round crimp-type terminal lug having an M3 insulating sleeve. A bare crimp-type terminal lug will cause a short-circuit. If a bare crimp-type terminal lug must be used, insulate it with a sleeve or the like, or point the terminal lugs in opposite directions to prevent a short-circuit.

Lead wire connection direction and recommended cutting sizes (unit: mm)

#### 1.1 For 3-core wires

- An example of standard connections using crimp-type terminal lug, having an insulation sleeve



- An example of insulating a bare crimp-type terminal lug with a mark tube or the like

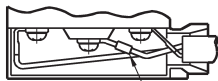

Mark tube or the like

- ✗ A wrong example of using a bare crimp-type terminal lug



Short circuit

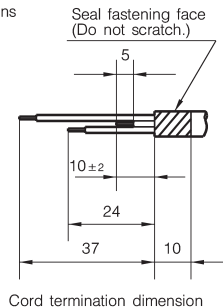

Cord termination dimension

#### 1.2 For 2-core wires

(unit: mm)

- An example of reversing the direction of a bare crimp-type terminal lug

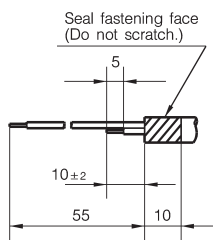

Cord termination dimension

### 2. Wiring

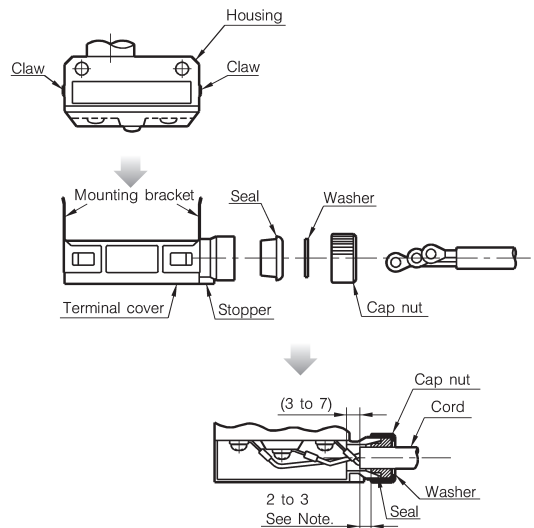

Note: Assemble these components so that the cable sheath protrudes 2 to 3 mm from the end of the seal.

- Add components to the cable in the order: cap nut, washer, seal and terminal cover.
- Make sure that the mounting bracket on the terminal cover is held by the catches of the housing in this snap-in structure. Then tighten with the cap nut.
- To remove the terminal cover, release the snap-in structure with a screwdriver by expanding the mounting bracket on one side.
- The cable can be drawn out rightward or leftward by changing the mounting direction of the terminal cover.
- Be careful since the terminal layout differs for the (roller) lever type and (roller) plunger type, as illustrated below.

(roller) lever type

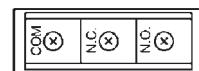

(roller) plunger type

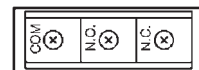

- A seal suitable for a cable diameter of 5.8 to 7.8 mm is attached to the terminal cover at the factory. If a cable of a different diameter is used, use replacement seal **SL1-PA22**, **SL1-PA23** or **SL1-PA24** (sold separately). To ensure a good seal, be sure to use a seal matching the diameter of the cable. If a question arises, please contact your nearest Azbil sales agent.
- Do not wire while the power is ON. There is a danger of injury by electrical shock or unexpected movement of the mechanism.
- Make sure that crimp terminals attached to wires do not come into contact with the cover or housing. If they do, the cover may not close properly or a ground fault may occur.
- Securely tighten the cap nut.  
Insufficient tightening impairs sealing performance, leading to insulation failure and eventually preventing the switch from performing satisfactorily.

### 3. Installing the switch

- Tighten each part of the limit switch to the appropriate tightening torque as described in the product specification. Overtightening will damage the threads or other parts. Insufficient tightening degrades the seal and other characteristics.
- Do not leave or use the switch with the terminal cover open. The entry of water or dust into the switch can lead to malfunction.
- Do not let the actuating object strike the lever arm or the switch head. If they do, the actuator may bend and the switch may not be able to return properly.
- Do not use leads with silicone rubber insulation, or silicone filler, or grease or oil containing silicone. They can cause contacts to fail to conduct electricity.

### 4. Adjusting the switch

- Do not apply excessive force (5 times the O.F. or more) to the actuator beyond the travel limit position. Doing so may damage the switch.
- Keep the overtravel between 1/3 and 2/3 of the rated value. With a small overtravel, vibration or shock may cause the contacts to rattle or to make poor contact.

### 5. Assembly of auxiliary parts

Actuator section (Do not apply a force that is 5 times the O.F. or more.)

1. Insert one of the tabs on the side of the housing into the mounting bracket on the terminal cover.

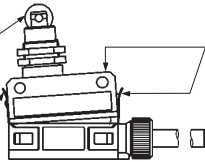

3. Check that the housing is completely inserted into the terminal cover. If not, switch performance requirements may not be satisfied.

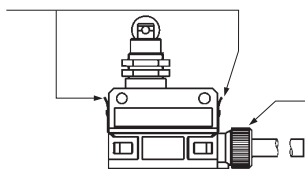

2. Push the housing straight down from above so that the other tab is completely inserted into the terminal cover mounting bracket. With the roller lever type (SL1-P\*\*), since the actuator is large there is little space to hold on the housing. If it is too difficult to insert by pushing the housing down, it can be relatively easily installed by pushing the terminal cover side.

4. When tightening the cap nut, do not hold the housing, but rather the terminal cover. If stress is applied to the housing and the compression of the O-ring becomes uneven, sealing performance requirements may not be satisfied.

### 6. Environment

- Do not use the switch in an environment where strong acid or alkali is directly splashed onto it.

### 7. Other cautions

- Do not apply a lubricant to the sliding part of the actuator or any other component. Application of an inappropriate lubricant may degrade sliding performance or impair the protective structure.
- Remove any foreign substances adhering to the sliding part. Dust or any other foreign substance attached to the sliding part may cause a malfunction.
- Check the actual load.  
To increase reliability, confirm that the switch has no problems in actual use before using the switch.

Before use, thoroughly read the "Precautions for use" and "Precautions for handling" in the Technical Guide on pages D-101 to D-112 as well as the instruction manual and product specification for this switch.



Please read "Terms and Conditions" from the following URL before ordering and use.

<https://www.azbil.com/products/factory/order.html>

*[Notice] Specifications are subject to change without notice.  
No part of this publication may be reproduced or duplicated  
without the prior written permission of Azbil Corporation.*

Other product names, model numbers and company names may be trademarks of the respective company.

## Azbil Corporation

Advanced Automation Company

*Yamatake Corporation changed its name to Azbil Corporation on April 1, 2012.*

1-12-2 Kawana, Fujisawa  
Kanagawa 251-8522 Japan

URL: <https://www.azbil.com>

1st Edition : Jan. 2018