

azbil



Compact Digital Mass Flow Controller

Model F4H



(fluoro rubber seal
model only)



A More Advanced Standard Model

A new high performance standard F4H mass flow controller has now arrived!

- 0.3 s high-speed controllability and 1 % SP high accuracy
- Wide-range 100:1 control is now available.



Compact × Quality

Compact × Quality



Ease of use **1** Compact Design Saves Space

Compact but equipped with the essential functions. These products help to save space.

Ease of use **2** Effectively Utilize Digital Communications

All models have communications functions for IoT compatibility.
RS-485 (CPL) / Modbus™ RTU

Ease of use **3** High Noise Tolerance

With isolation of the power supply from the signal circuit, power supply noise can't affect analog signals. Additionally, highly noise-resistant 4 to 20 mA signals can be used.

Ease of use **4** Reduction in Overall Cost

Overall cost is lower for reasons such as: communication functions eliminate the need for an analog I/O module; 24 Vdc operation eliminates the need for a dedicated power supply; and multi-gas/multi-range capability allows reduction of inventory.

The Micro Flow Sensor

Structure High-sensitivity, high-speed response mass flow sensor using a platinum thin-film circuit on a silicon chip.

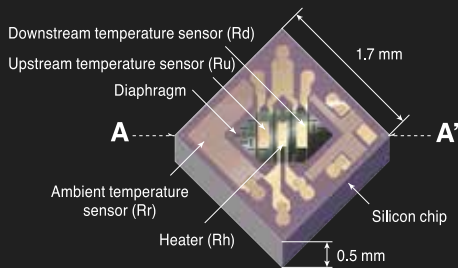

Section A-A'

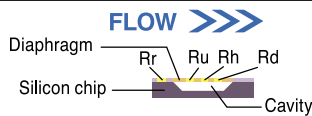

Principle of measurement

When there is no gas flow, the temperature distribution around the heater is symmetrical. When gas flows from Ru to Rd, the symmetry in temperature is distorted toward the Rd (downstream) side. The temperature difference between Ru and Rd is used to calculate the flow rate.

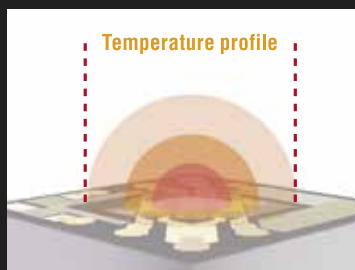

When there is no flow

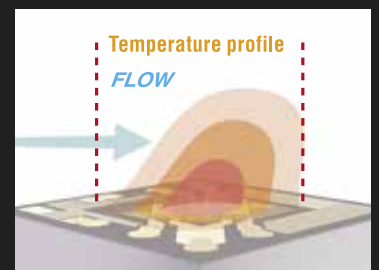

When gas is flowing

Structure of Micro Flow Products

Because the Micro Flow sensor, whose constituents have extremely low heat capacity, is in direct contact with the process gas, flow rate fluctuations can be detected instantly as changes in temperature.

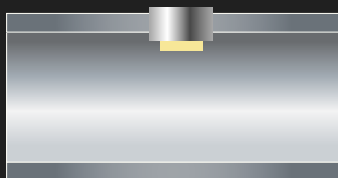

By incorporating Azbil's PID control technology, a high-speed response control of 0.3 s has been achieved.

Control Characteristics

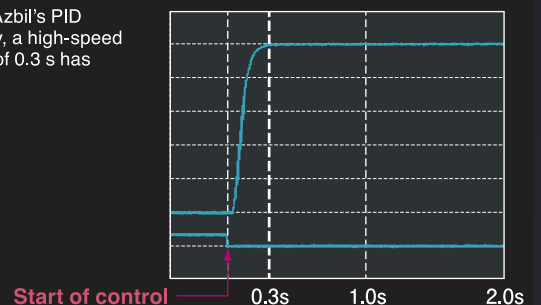

Ease of use **1** Compact Design Saves Space

The new products are 50 % smaller than our conventional models.

With a width of 28 mm, the product's slim design allows closer spacing of pipes, saving more space.

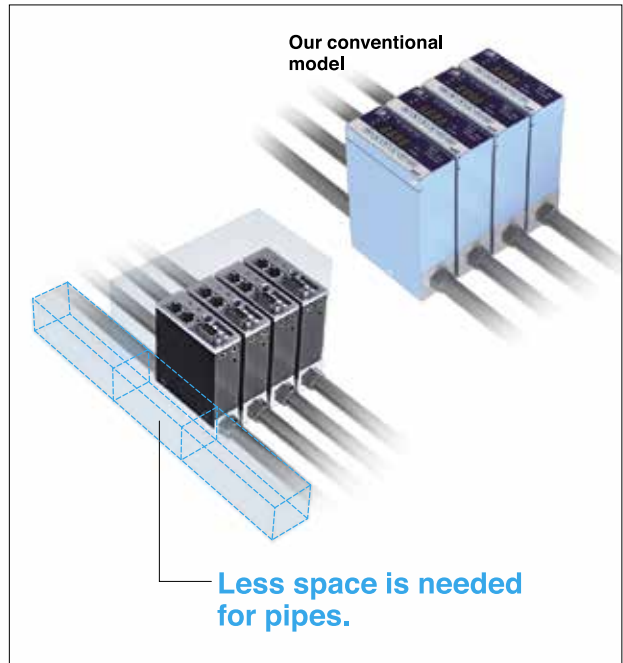
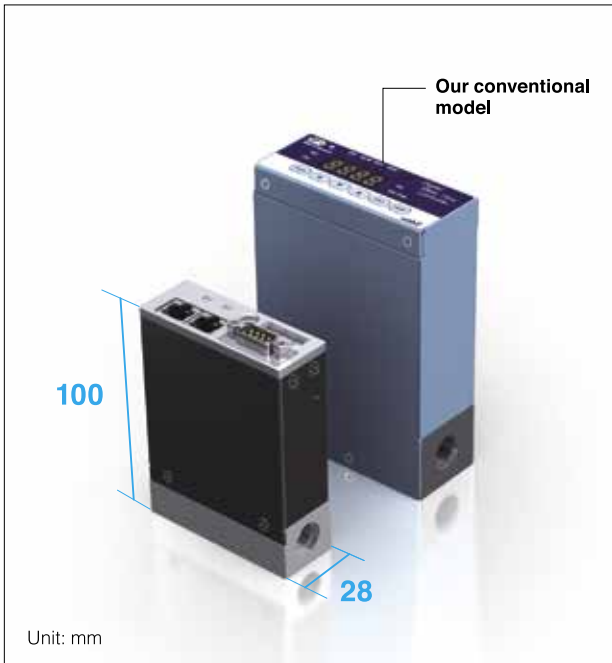

Ease of use **2** Effectively Utilize Digital Communications

RS-485 (CPL) / Modbus™ RTU

Analog mass flow controllers can communicate only flow rate to programmable logic controllers.



With **model F4H's communication functions**, much information useful for fault diagnosis can be uploaded. Also, with a model NX-SVG, model F4H can communicate with major programmable logic controllers without the need for programming.

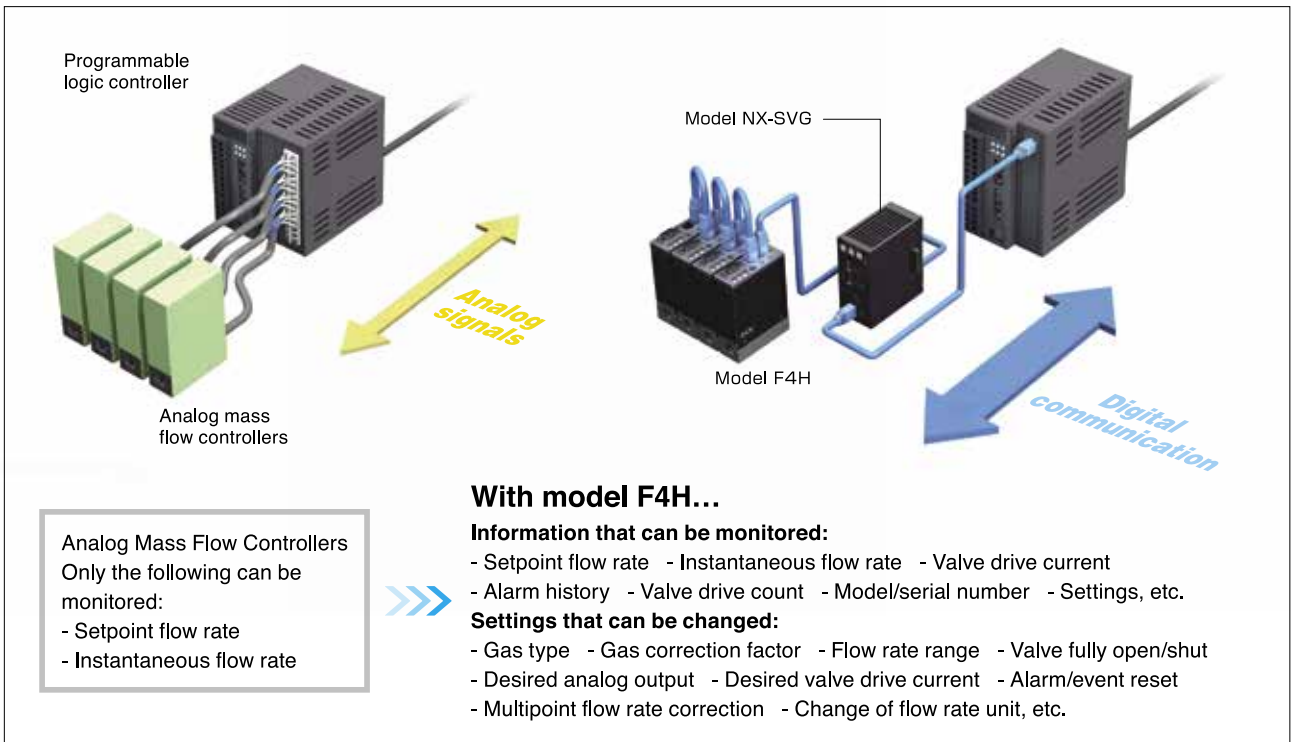

Ease of use **3** High Noise Tolerance

Isolation of the power supply from the signal circuit

By isolating the valve drive circuit from other circuits, power supply circuit and analog circuit isolation (patent No. 5132617) is achieved, even with a small-capacity isolated power supply. Thanks to this feature, noise from power wiring has no effect on signals.

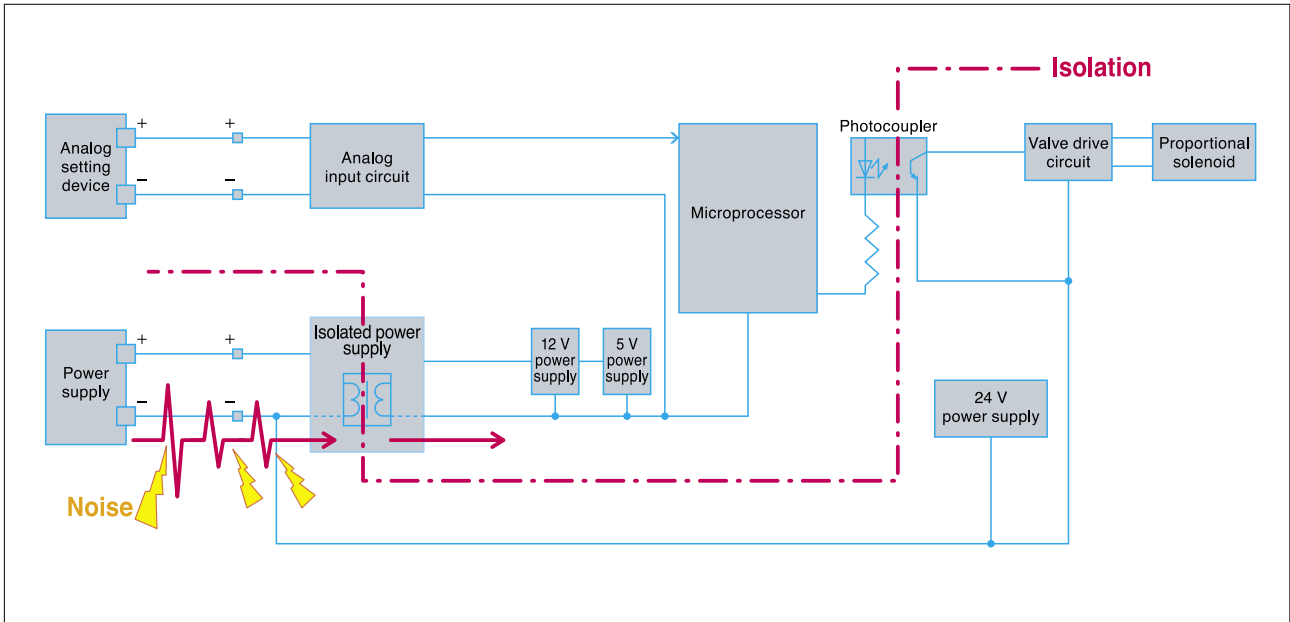

Ease of use **4** Reduction in Overall Cost

Point ①

By switching from an analog to a digital connection with the PLC, the analog I/O module can be eliminated.

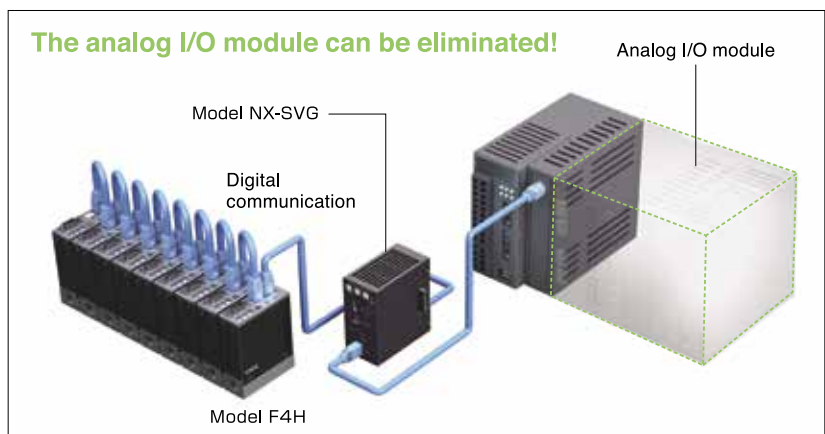

Point ②

Since these products run on 24 Vdc, a dedicated ± 15 V power supply is not required. Also, since the power supply is isolated from the signal circuits, supplying power from a single source to multiple model F4H units will not create a cyclic circuit.

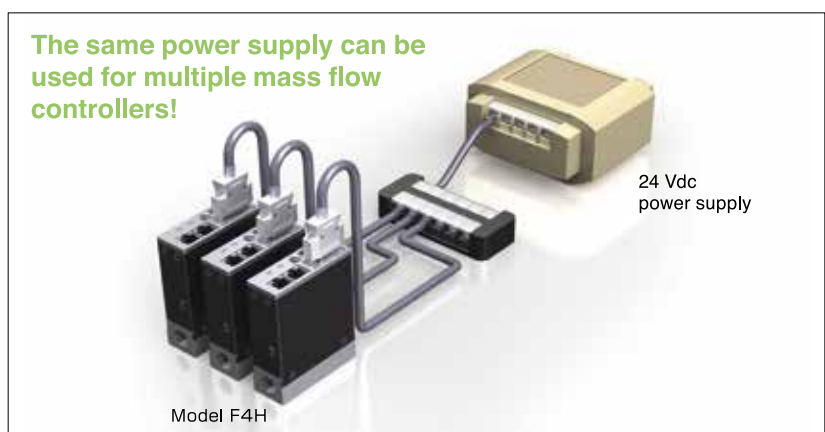

Functions

Function	Description
Selection of analog signal type	Analog input/output can be selected from 0 to 5 Vdc, 1 to 5 Vdc, and 4 to 20 mAcd.
Operation at alarm/event occurrence	Control in the event of an alarm or event can be selected from: (1) Continue, (2) Force valve fully closed, and (3) Force valve fully open.
External contact input function	The external contact input function can be selected from: (1) Force valve fully closed, (2) Force valve fully open, and (3) Reset alarm.
Setup of flow rate control range	The flow rate control range can be set down to one tenth of the standard range.
Gas type setup	Changing the settings allows use with the following gas types. Air model: air/nitrogen, argon, carbon dioxide, hydrogen, and helium Oxygen model: oxygen, air/nitrogen, argon, carbon dioxide, hydrogen, and helium
Selection of flow rate standard condition	The conversion reference temperature setting for displaying measurements in terms of the volumetric flow rate can be changed.
PV filter	This function can be used to average the instantaneous flow rate.
Settings for vertical piping	This function adjusts any drift caused by installation on a vertical pipe.
Setup from PC (loader function)	A port for connecting a PC loader is provided as a standard feature. Using the dedicated PC loader, you can change settings or monitor internal data from a computer.
SP ramp control function	To prevent a rapid change in the flow rate, this function sets a maximum rate of change for the setpoint flow rate (SP) when control starts or when the flow rate setting is changed.
Valve drive current event settings	This function generates an event if the valve drive current deviates from a set range.
Multipoint flow rate correction	This function corrects the flow rate measurement at four points for each flow rate region. It is used to adjust the flow rate after flow rate calibration.
Manual output of flow rate signal	This function forces output of flow rate output signals. It is used for loop checking after the wiring has been completed.
Analog scaling function	Any flow rate can be set within the full-scale analog input/output range.
Control optimization	The optimal control parameters can be selected according to the operating differential pressure.
Change of flow rate unit	The flow rate unit can be selected from: (1) L/min or mL/min, (2) m ³ /h or L/h, and (3) g/min or mg/min.
Manual setting of valve drive current	This function fixes the valve drive current at a certain value, providing an effective means of determining whether the cause of unstable flow rate control is a control error by this product or an external factor.
Storing of alarm history	Alarm history is saved in order of alarm occurrence.
Valve drive count	The number of times the valve closes fully is saved. This count is used as a guide for determining when the device needs to be replaced.

Control Flow Rate Range by Gas Type

	Model F4H9050		Model F4H9200		Model F4H9500	
	Control range (mL/min)	Set resolution *1 (mL/min)	Control range (mL/min)	Set resolution *1 (mL/min)	Control range (mL/min)	Set resolution *1 (mL/min)
Air / Nitrogen	1.00 to 50.00	0.05	2.0 to 200.0	0.2	5.0 to 500.0	0.5
Oxygen	1.00 to 50.00	0.05	2.0 to 200.0	0.2	5.0 to 500.0	0.5
Argon	1.00 to 50.00	0.05	2.0 to 200.0	0.2	5.0 to 500.0	0.5
Carbon dioxide	0.60 to 30.00	0.05	1.2 to 120.0	0.2	3.0 to 300.0	0.5
Hydrogen	4.0 to 200.0	0.2	8.0 to 800.0	0.5	20 to 2000	2
Helium	4.0 to 120.0	0.2	8.0 to 800.0	0.5	20 to 1200	2

	Model F4H0002		Model F4H0005		Model F4H0020	
	Control range (L/min)	Set resolution *1 (L/min)	Control range (L/min)	Set resolution *1 (L/min)	Control range (L/min)	Set resolution *1 (L/min)
Air / Nitrogen	0.020 to 2.000	0.002	0.050 to 5.000	0.005	0.20 to 20.00	0.02
Oxygen	0.020 to 2.000	0.002	0.050 to 5.000	0.005	0.20 to 20.00	0.02
Argon	0.020 to 2.000	0.002	0.050 to 5.000	0.005	0.20 to 20.00	0.02
Carbon dioxide	0.012 to 1.200	0.002	0.030 to 3.000	0.005	0.12 to 12.00	0.02
Hydrogen	0.080 to 8.000	0.005	0.20 to 20.00	0.02	0.80 to 60.00	0.05
Helium	0.080 to 8.000	0.005	0.20 to 12.00	0.02	0.80 to 50.00	0.05

Note: Set a flow rate within the control ranges shown above.

*1 It's values when Display resolution(C-41) is high resolution.

Model Selection Guide

Basic model No.			Control flow rate				Flow path	Pipe connection	Gas type	Conn. type	O-ring	Gas type (default)	Option 1	Option 2	Option 3	Appended No.	Remarks		
F	4	H																	
			9	0	5	0											1.00 to 50.00 mL/min *1		
			9	2	0	0											2.0 to 200.0 mL/min *1		
			9	5	0	0											5.0 to 500.0 mL/min *1		
			0	0	0	2											0.020 to 2.000 L/min *1		
			0	0	0	5											0.050 to 5.000 L/min *1		
			0	0	2	0											0.20 to 20.00 L/min *1		
							6										SUS316 (degreased for gas-contacting parts)		
								U									UNF		
								T									Rc fitting		
								S									Swagelok fitting or equivalent		
								V									VCR fitting or equivalent		
									N								Air / Nitrogen *2		
									S								Oxygen *3		
										2							RS-485 CPL model		
										3							RS-485 Modbus™ model		
											0						O-ring material: fluororubber		
												N					Factory setting: air/nitrogen *2		
												S					Factory setting: oxygen *3		
													0				None		
														0			None		
															0		None		
																D	With an inspection report		
																	Y	With traceability certificate	
																		0	Product version

*1. Flow rate setting range for air, nitrogen, argon, and oxygen. For other gases, see the control flow rate range by gas type in the preceding section.

*2. If the gas type is "N", "S" cannot be selected for "Gas type (default)."

*3. If the gas type is "S", only "S" can be selected for "Gas type (default)."

Optional Parts

D-SUB 9-pin analog cable assembly	81447655-001
1/4" Rc fitting (set of 2)	81446834-001
1/4" Swagelok fitting or equivalent (set of 2)	81447653-001
1/4" VCR fitting or equivalent (set of 2)	81447654-001
AC adapter	81446957-001
Loader communication cable	81441177-001
Network Instrumentation Module Smart Device Gateway*	NX-SVGN00000

* A communication gateway that allows the interchange of information between various kinds of control device without programming, enabling smarter development work.

Specifications

Compact Quality

Model	F4H9050	F4H9200	F4H9500	F4H0002	F4H0005	F4H0020	
Valve operation	Normally closed when de-energized (N.C.)						
Full-scale flow rate (air)	*1 50.00 mL/min	200.0 mL/min	500.0 mL/min	2.000 L/min	5.000 L/min	20.00 L/min	
Gas types	*2 Air/nitrogen model: air/nitrogen, argon, carbon dioxide, hydrogen, and helium (switchable by setting) Oxygen model: oxygen, air/nitrogen, argon, carbon dioxide, hydrogen, and helium (switchable by setting)						
Control	Repeatability	± 0.2 % FS ± 1 digit					
	Accuracy (under reference conditions)	± 1 % FS					
	Offset of PV from SP	± 0.1 % FS ± 1 digit max.					
	Response (at standard differential pressure)	Time from zero flow rate setting until statically determinate at ± 2 % FS: 0.3 s (typ.) *10					
Pressure	Operating differential pressure range	*4 Ambient temperature: -10 ≤ t ≤ 40 °C 20 to 200 kPa	50 to 300 kPa	100 to 300 kPa	50 to 300 kPa	100 to 300 kPa *11	180 to 300 kPa *11, *12
		Ambient temperature: 40 < t ≤ 50 °C 20 to 200 kPa	100 to 30 kPa	150 to 300 kPa *6	100 to 300 kPa	150 to 300 kPa *11	Usage prohibited
	Standard differential pressure (outlet pressure = 0 kPa (gauge))	*5 100 kPa	200 kPa				
	Allowable inlet pressure	0.5 MPa (gauge) max.					
	Pressure resistance	1 MPa (gauge)					
Temperature	Pressure characteristics (horizontal installation, per 100 kPa with air)	±1.0 % FS max.	±0.5 % FS max.	±0.2 % FS max.	±0.2 % FS max.	±0.2 % FS max.	±0.2 % FS max.
	Allowable operating temperature range	- 10 to + 50 °C					
	Allowable storage temperature range	- 20 to + 70 °C					
Humidity	Temperature characteristics	±0.2 % FS per 1 °C max.					
		± 0.1 % FS per 1 °C max.					
Leakage	Allowable operating humidity range	10 to 90 % RH (without condensation)					
	Allowable storage humidity range	10 to 90 % RH (without condensation)					
Analog input for flow rate setting	Helium external leakage rate	1x10 ⁻⁸ Pa · m ³ /s					
	Setting resolution	3,000					
Analog output for instantaneous flow rate	Input range	0 to 5 Vdc (factory setting), can be switched to 1 to 5 Vdc or 4 to 20 mAdc by host communication or PC loader					
	Input impedance	Voltage input type: 1 MΩ ± 10 %. Current input type: 250 Ω ± 10 %					
External contact input	Output range	0 to 5 Vdc (factory setting), can be changed to 1 to 5 Vdc or 4 to 20 mAdc by host communication or PC loader					
	Maximum output	110 % min. (120 % max.)					
Digital output	External resistance	Voltage output type: 250 kΩ min., current output type: 300 Ω max.					
	Number of inputs / use	One input: "Force valve open," "Force valve closed," "Zero flow rate correction," and "Alarm reset" (change by changing the setting)					
	Required circuit type	Non-voltage contacts or open collector					
	Contact OFF terminal voltage	4.5 ± 1 V					
	Contact ON terminal current	Approx. 0.5 mA					
Communications	Allowable ON residual voltage	0.8 V max.					
	Allowable OFF leakage current	50 μA max.					
	Number of outputs	One output					
	Output rating	30 Vdc, 30 mA max. (non-isolated open collector output)					
Power	OFF leakage current	0.5 μA max (Vcc = 30 V 25 °C)					
	ON residual voltage	1 V max.					
	Number of units connectable	31 units					
	Communication method	RS-485 (3-wire system)					
Connection method	Protocol	CPL communication, Modbus™ RTU (select either by model number when ordering)					
	Communication speed	9600 19200 38400bps					
	Connection	RJ45 x 2					
Mounting orientation	Rating	24 Vdc, current consumption: 300 mA max.					
	Allowable power voltage range	22.8 to 25.2 Vdc (ripple 5 % max.)					
Material of gas-contacting parts	Isolation	The power circuit is isolated from the input/output circuit.					
	Weight	9/16-18 UNF, 1/4" Rc, 1/4" Swagelok or equivalent, 1/4" VCR or equivalent					
Standards compliance	Mounting orientation	Only horizontal	Horizontal (top panel surface cannot face downward) or vertical *7, *8				
	Material of gas-contacting parts	Standard gas or oxygen model: SUS316, fluorocarbon resin, fluororubber					
	Weight	Approx. 700 g (excluding fitting)					
	Standards compliance	EN 61326-1:2013, EN 61326-2-3:2013 *9					

*1. mL/min and L/min are volumetric flow rate per minute (L/min) converted to conditions of 0 °C and 101.325 kPa (1 atm). The controllable flow rate range varies depending on the gas type. *2. Dry gas that does not contain chlorine, sulfur, acid, or other corrosive ingredients. Also, clean gas that does not contain dust or oil mist. *3. Difference between devices when measured using Azbil equipment under the reference conditions *4. Operation is possible even below the operating differential pressure range, but the controllable flow rate range is narrower. *5. Differential pressure during product calibration *6. Make sure that the power is at least 23.5 Vdc. *7. An measurement error may occur if the flow direction is vertical. Set function code C-34, "Piping orientation setting" according to how the device is mounted, and then change parameter P-23, "Primary pressure specification," according to the pressure used. *8. Model F4H9050 cannot be mounted vertically.

*9. During EMC testing, the reading may fluctuate by the equivalent of ± 5 % FS, or the output value may fluctuate. *10. For F4H0020, C-36 (operating differential pressure) is set to "0: Low differential pressure." *11. Use within a power supply voltage range between 23.5 and 25.2 V.

*12. The maximum operating differential pressure varies according to the power supply voltage. See the following graph. The operating differential pressure range for argon is from 250 to 300 kPa.

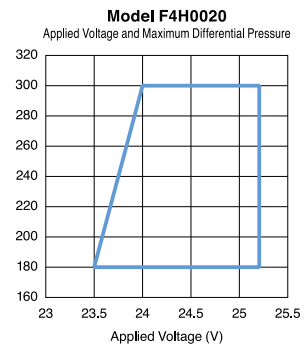

Reference conditions:

- Fluid: Air
- Fluid pressure: Standard differential pressure ± 5 %
- Ambient temperature: 23 ± 3 °C
- Power supply voltage: 24 Vdc ± 2 %
- Warm-up time: Leave at the ambient temperature for at least 2 hours and then for at least 30 min after turning on the power
- Vibration: 0 m/s²
- Mounting direction: Position so that the top panel faces up
- Straight pipe length: 50 mm min. for upstream straight pipe, 25 mm min. for downstream straight pipe
- Piping: Use Azbil's standard pipe coupling (Rc/Swagelok or equivalent, VCR or equivalent). If an Rc pipe coupling is used, the inside diameter of the straight pipe must be 4 mm min.
- Gas temperature: Ambient temperature ± 1 °C
- Gas dew point temperature: -18 °C max.

Analog Power Connector: D-SUB 9-pin

Pin number	Pinout	Description	Remarks
1	DI	Contact input (+)	
2	FLOW RATE OUTPUT +	Flow rate output (+)	0 to 5 Vdc / 1 to 5 Vdc / 4 to 20 mA output
3	POWER (24 V)	24 Vdc power (+)	
4	N.C.	-	
5	POWER (GND)	Power GND	
6	FLOW RATE SP INPUT +	Flow rate setpoint input signal (+)	0 to 5 Vdc / 1 to 5 Vdc / 4 to 20 mA input
7	A.GND	Instantaneous flow rate output (-) Instantaneous flow rate setup input (-)	Common ground for analog signals
8	D.GND	External contact input (-) Digital output (-)	Common ground for digital signals
9	DO	Alarm output (+)	Open collector output

RS-485 Connector: RJ45

Pin number	Pinout
1	SG
2	SG
3	N.C.
4	DB (D-)
5	DA (D+)
6	N.C.
7	N.C.
8	N.C.

*Common to CPL and Modbus™ RTU

* SG is connected to A.GND and G.GND on the connector for external connection.

External Wiring Connector

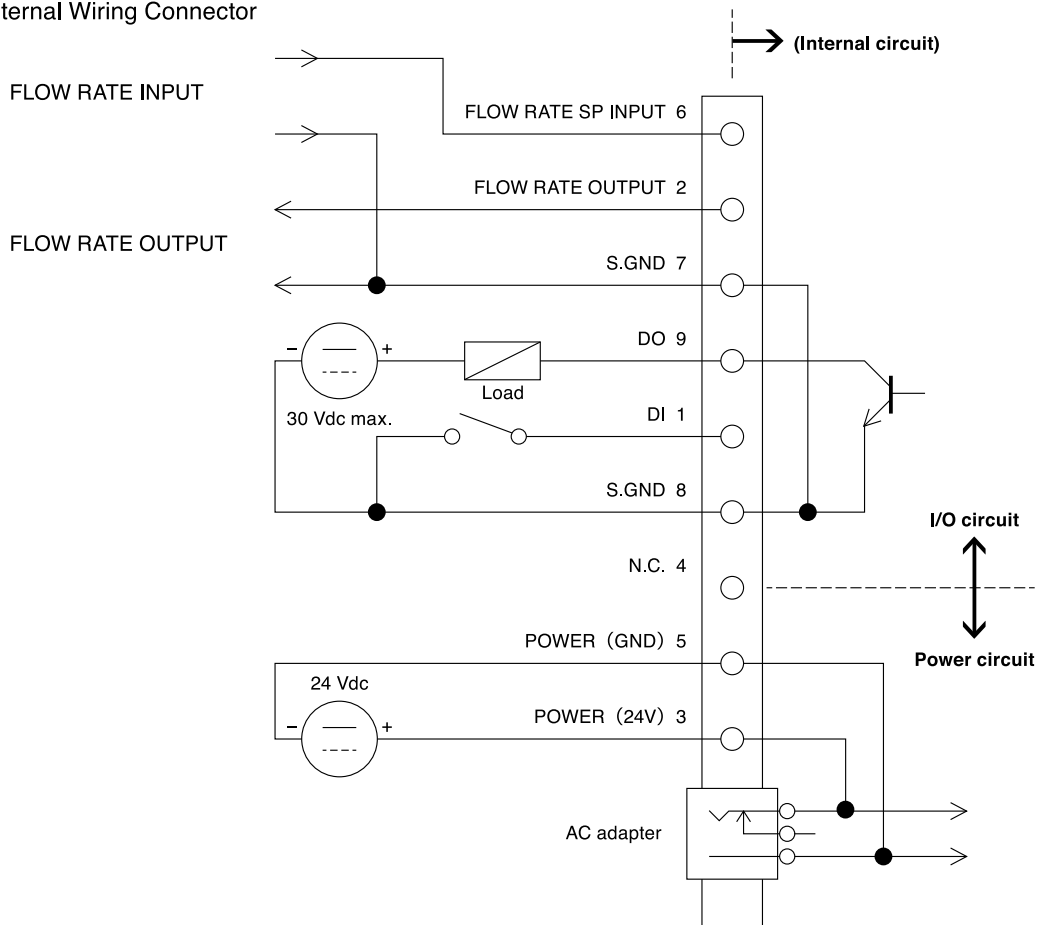

Mass Flow Controller

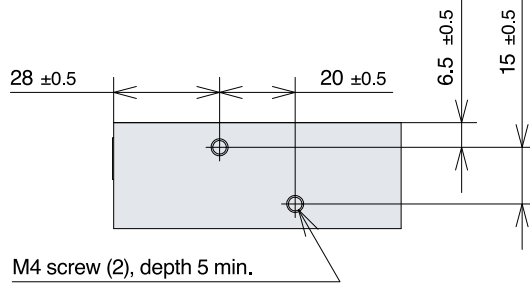
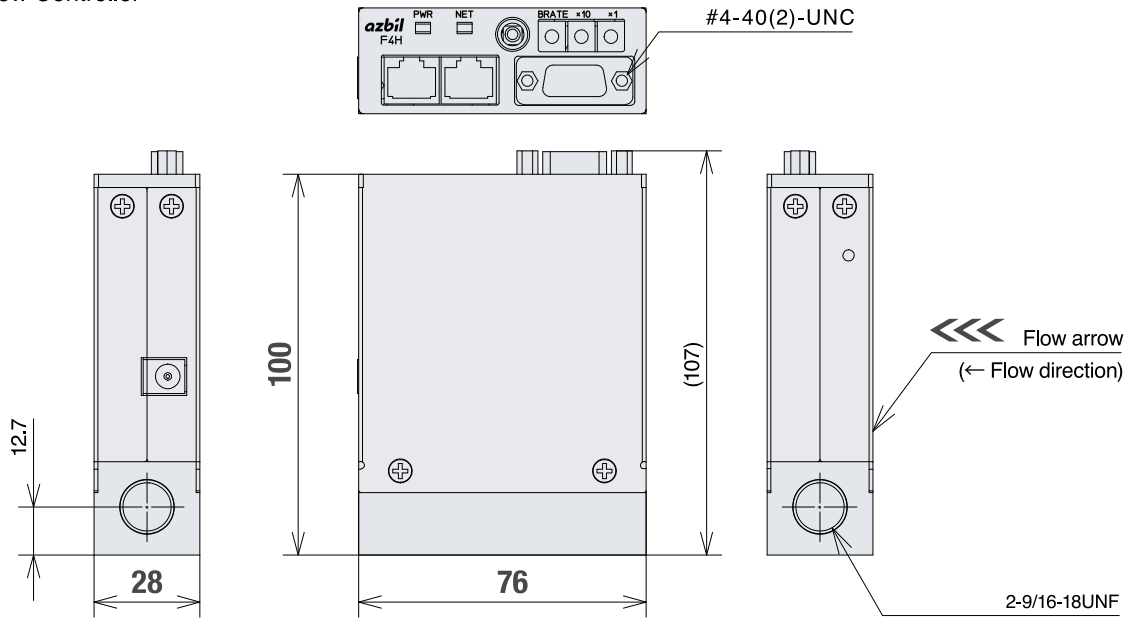

1/4" Swagelok or Equivalent Fitting Type

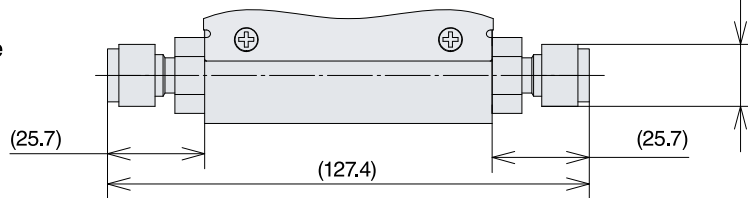

1/4" VCR or Equivalent Fitting Type

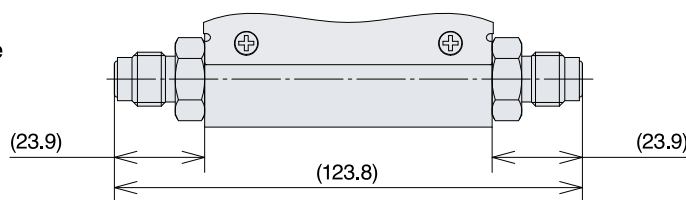

1/4" Rc Connection Type

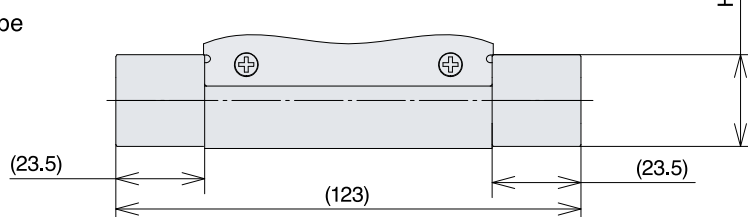

D-SUB 15PIN cable (Type:81447655-001)

Pin number	Line color
1	Blue
2	Brown
3	Rec
4	none
5	Black
6	Green
7	Gray
8	White
9	Yellow

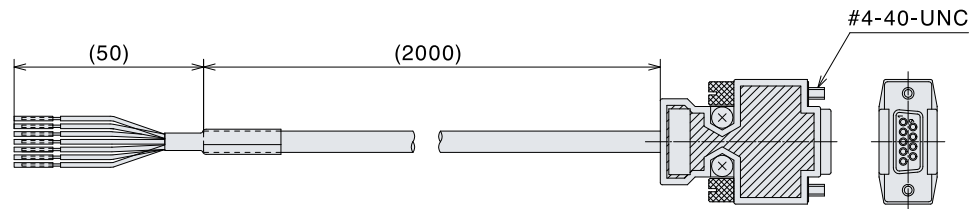

AC adopter (Type:81446957)

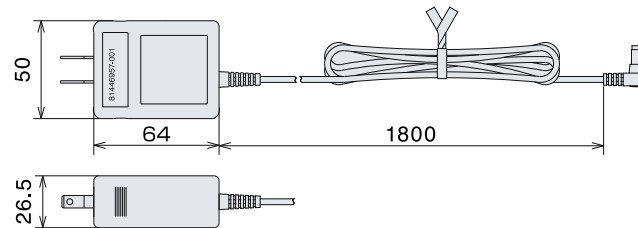

>>> Cautions for Flow Controllers

(For installation and use of this device, refer to the warnings and cautions in the user's manual.)

- Never allow gases that are within explosive limits to pass through this device. Doing so might result in an explosion.
- Never use a flow controller for oxygen gas if it is not a special oil-free oxygen gas model. Doing so could cause the gas to ignite.
- Prevent foreign matter from entering the device. Rust, water droplets, oil mist, or dust from the pipes can cause measurement error, control error, or damage to the device. If there is a possibility of foreign matter entering the device, provide an upstream filter, strainer or mist trap capable of eliminating foreign matter 0.1 μm and greater in diameter. Be sure to inspect and replace the filter at regular intervals.
- Use the device within the operating differential pressure range. Failure to do so may cause flow rate hunting to occur. If hunting persists, valve failure may occur. Also, if this device is operated with a differential pressure exceeding the maximum operating differential pressure, the control flow rate may not reach the flow rate setpoint.
- Do not subject this device to pressure beyond its rated pressure resistance. Doing so might result in damage.
- When using a relay for external contact input, always use a relay designed for micro-current use (with gold contacts). Failure to do so could cause faulty contact, resulting in malfunction.
- Do not connect the following in the vicinity of the downstream side of this device: a throttling device or a device that causes a high pressure loss. Doing so may cause flow rate hunting to occur.
- If this device is installed in an environment with large temperature fluctuations, even if the temperature drops when the device is not in use, replace the internal air with gas that is sufficiently dry to prevent condensation. Condensation may cause the device to malfunction.
- Never use this device in a potentially explosive atmosphere or where it will be exposed to a flammable liquid or vapor.
- Use the specified pipe fittings and gaskets and verify that there is no leakage after completion of the piping work. Failure to do so may result in gas leaks.
- The valve on this device cannot completely shut off a flow. If complete shutoff is required, install a separate shutoff valve.

Support for programless communication

with Network Instrumentation Module Smart Device Gateway* Model NX-SVG

* A communication gateway that allows the interchange of information between various kinds of control device without programming, enabling smarter development work.

Feature1 Dramatically speeds up development with programless communication

Feature2 Connect multivendor devices on the network

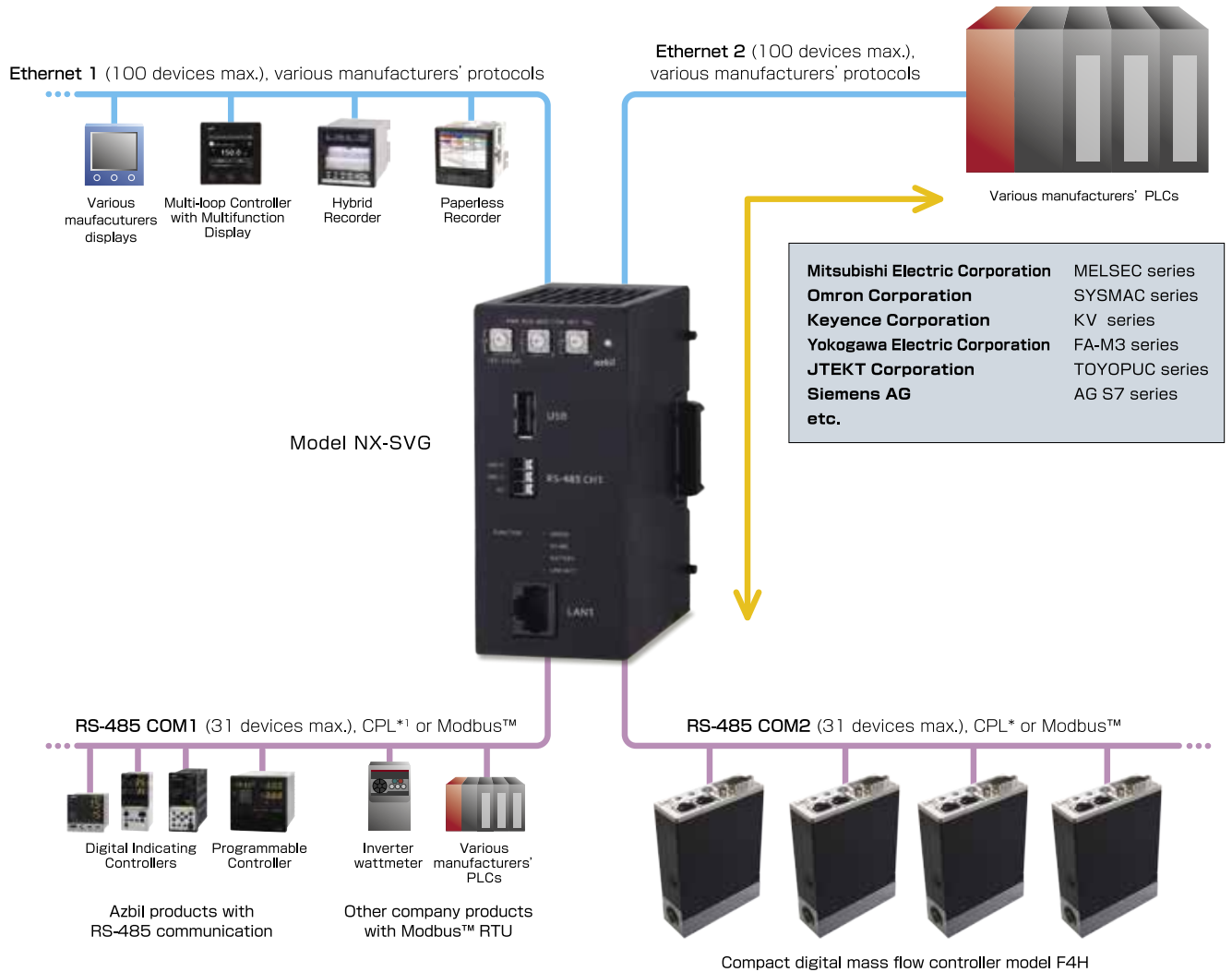

*1 Controller Peripheral Link: Azbil Corporation's host communication protocol

Please read "Terms and Conditions" from the following URL before ordering and use.
<https://www.azbil.com/products/factory/order.html>

Ethernet is a registered trademark of XEROX Corporation. Modbus is a trademark and the property of Schneider Electric SE, its subsidiaries and affiliated companies. MELSEC is a trademark of Mitsubishi Electric Corporation. TOYOPUC is a trademark of JTEKT Corporation. SYSMAC is a trademark of Omron Corporation. Other product names, model numbers and company names may be trademarks of the respective company.

[Notice] Specifications are subject to change without notice.
 No part of this publication may be reproduced or duplicated without the prior written permission of Azbil Corporation.

Azbil Corporation
 Advanced Automation Company

1-12-2 Kawana, Fujisawa
 Kanagawa 251-8522 Japan

URL: <https://www.azbil.com>

1st Edition : Aug. 2016-SK
 4th Edition : Mar. 2020-SK/AZ